



VM9224BT

Operating Instructions



160 watts peak
40W x 4

CONTENTS

Thank you for choosing a Jensen product. We hope you will find the instructions in this owner's manual clear and easy to follow. If you take a few minutes to look through it, you'll learn how to use all the features of your new Jensen VM9224BT Mobile Multimedia Receiver for maximum enjoyment.

Features	1
Controls and Indicators	4
Operating Instructions	6
Setup Menu	11
Tuner Operation	17
DVD/VCD Video Operation	21
DVD/CD Audio Operation	27
MP3/WMA Operation	30
iPod® Operation	34
Bluetooth Operation	38
Troubleshooting	45
Specifications	49

FEATURES

Congratulations on your purchase of the Jensen VM9224BT Mobile Multimedia Receiver.

It's a good idea to read all of the instructions before beginning the installation. We recommend having your Jensen VM9224BT installed by a reputable installation shop.

DVD

- Fast Forward/Reverse - 2X, 4X, 8X and 20X
- Slow Motion Forward/Reverse - 1/2, 1/4, 1/6 and 1/8
- Play, Pause, Stop, Next Chapter and Previous Chapter

CD / MP3 / WMA

- CD-Text Compatible
- ID3 Tag Compatible
- Directory Search (MP3 / WMA Only)
- Burn up to 1500 MP3 and WMA Files onto a DVD±R / RW
- Audible Forward / Reverse Track Search (CD-DA Only)
- Random, Repeat and Intro
- Play, Pause, Stop, Next Track and Previous Track

AM-FM

- USA / Europe / Latin America / Asia Frequency Spacing
- 30 Station Presets (18 FM / 12 AM)
- Auto Stereo / Mono
- Local / Distance
- Auto Store / Preview Scan

iPod®

- iPod via USB
- High Speed Direct Connect Interface to Access iPod Playlists, Artists, Albums and Songs. Play music and view video/photo* files from your iPod. *Video/photo playback requires jLink-USB iPod interface cable (sold separately).
- Power Management Charges iPod while Connected

Chassis

- 2.0 DIN (Import / ISO-DIN Mountable)
- Fixed Front Panel
- 6.2" High Definition TFT LCD
- 1,152,000 Sub Pixels (800x3 X 480)
- Beep Tone Confirmation (ON-OFF Option)
- Heat Management System - Forced-Air Cooling To Keep The Chip-Sets Operating at Nominal Temperatures

General

- Navigation Ready (NAV102)

- Built-in Bluetooth, providing hands-free profile for safety and convenience and A2DP profile for streaming music from a PDA/PMP
- One Composite Video Output for Additional Screens
- Front Panel Audio/Video Input
- Three-Band Tone control (Bass, Mid and Treble) with Eight Preset EQ Curves
- Front Panel A/V Aux Input for Portable Media Devices
- Front, Rear and Subwoofer Line Output
- Programmable Volume Control
- Rear Camera Input (Normal and Mirror Image View)
- Touch Screen Calibration Mode
- 2VRMS Line Output - All Channels
- Rotary Encoder Audio Control
- SWC Interface – Compatible with PAC adapter SWI-PS Steering Wheel Control Interface (sold separately)

Optional Equipment

- **NAV102**

The VM9224BT is "navigation ready." Before accessing any navigation features, you must purchase and install the navigation module (NAV102). All installation and operating instructions will be included with the navigation module.

Once the navigation module is connected and operating properly, the NAV source mode will become active. While the navigation module is not installed, the NAV option appears gray, indicating the function is not available.

- **Bluetooth Phone**

See "Bluetooth Operation" on page 38.

- **Rear Camera**

The VM9224BT is "camera ready." Before accessing any camera features, you must purchase and install a rear video camera. Once the camera is connected and operating properly, the CAMERA source mode will become active. While the camera is not installed, the CAMERA option appears gray, indicating the function is not available.

WARNING! Never install this unit where operation and viewing could interfere with safe driving conditions.

WARNING! To reduce the risk of a traffic accident (except when using for rear view video camera) never use the video display function while driving the vehicle. This is a violation of federal law.

WARNING! Never disassemble or adjust the unit.

WARNING! To prevent injury from shock or fire, never expose this unit to moisture or water.

WARNING! Never use irregular discs.

WARNING! To prevent damage to the mechanism inside this unit, avoid impact to the TFT monitor.

WARNING! The monitor employs an automatic motorized mechanism. To prevent damage to the core mechanism, please do not push, pull or swivel the monitor manually.

CONTROLS AND INDICATORS

1. Disc Slot

2. RESET

Press to reset system settings to factory default (except password and parental lock settings).

3. EJECT

Press to eject a disc.

Press and hold to reset core mechanism position.

4. SRC

Press to turn the unit on. *Press and hold* to turn the unit off.

When on, press once to select playing mode.

5. NAV

Press to display the navigation user interface.

6. TFT Display

7. Rotary Encoder

Rotate to adjust the volume. While in the audio menu, press and release to enter and/or confirm audio settings.

Press to activate the MUTE function and silence the receiver. Press again to resume sound.

Press and hold to activate the Local (LOC) setting. *Press and hold* again to turn Local reception off.

8. USB/SD Interface Connector

Connect a USB device or insert an SD card for playback of music/video files.

9. A/V Input

Attach a compatible A/V device.

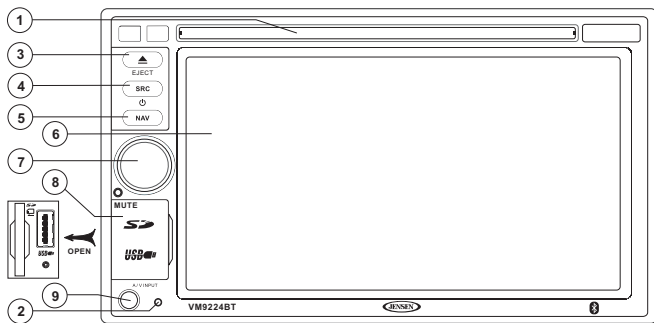

OPERATING INSTRUCTIONS

Power On / Off

Press the **⏻/SRC** button (4) to turn the unit on. The buttons on the front of the unit light up and the current mode status appears on the LCD (7).

Press and hold the **⏻** button to power off the unit.

Audible Beep Confirmation

An audible beep tone confirms each function selection. The Beep tone can be disabled through the Setup menu.

Mute/Line Mute

Press the rotary encoder button (7) to mute the volume from the unit. Press the rotary encoder button again to restore the volume. "MUTE" is displayed on the LCD. Adjusting the volume or using any of the audio setup features cancels the mute function.

If the "MUTE" wire is connected, audio output mutes when a telephone call is received by the car phone or when verbal navigation is performed (using optional NAV102).

Playing Source Selection

When the monitor is closed, press the **SRC** button (4) to change between available audio playing sources in the following order: RADIO, DISC, USB1, USB2, SD, BT, NAV, AUX and CAMERA.

Source Menu

You can also use the touch screen to change the source through the SOURCE MENU. To access the SOURCE MENU, touch the top left corner of the screen or press the **SRC** button (4).

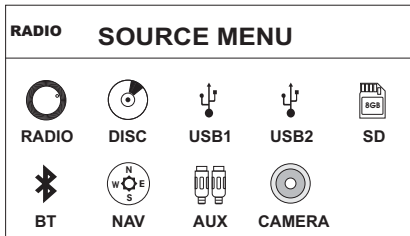

Touch the RADIO, DISC, USB1, USB2, SD, BT, NAV, AUX or CAMERA button to select the corresponding source.

NOTE: If an iPod® is attached to a USB1 port, "IPOD" appears instead of the text "USB1."

External Devices

External peripheral devices, including a game console, camcorder, navigation unit, iPod, Zune, etc. can be connected to this unit via RCA output using an A/V Media Adapter Cable (not included).

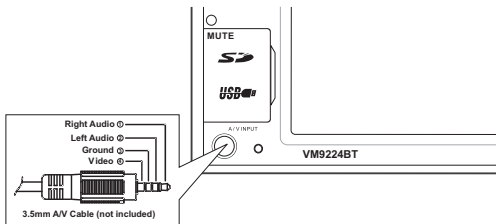

Connect the external device to the A/V Media Adapter Cable and then plug the cable into the **A/V INPUT** connector (9) on the front of the radio. Select "AUX" or "AUX IN" (when monitor is closed) mode to access auxiliary devices. You cannot directly control external devices connected to the **A/V INPUT**. For information regarding the use of USB devices, see "Inserting a USB Device or SD Card" on page 31.

Volume Adjustment

Volume Increase/Decrease

To increase or decrease the volume level, turn the rotary encoder (7). When the volume level reaches "0" or "40", a beep sounds, indicating that the adjustment limit has been reached. The TFT screen displays the volume level for 3 seconds.

Programmable Turn-On Volume

This feature allows the user to select a turn-on volume setting regardless of the volume setting prior to turning the unit off.

To program a specific turn-on volume level, turn the rotary encoder (7) to adjust the volume to the desired turn-on level. *Push and hold* the rotary encoder while the speaker icon and level indication is displayed on the screen. The unit will beep to confirm your turn-on volume setting.

Audio Control Menu

The Audio Control feature allows you to easily adjust your audio system to meet the acoustical characteristics of your vehicle, which vary depending on the type of vehicle and its measurements. Proper setting of the Fader and Balance boosts the effects of the cabin equalizer.

- Touch the **EQ** button on the left side of the screen to display the audio menu.
- Use the touch screen +/- buttons to adjust the settings for an audio feature.

Table 1: Audio Adjustments

Audio Function	Adjustable Range
EQ	User
	Acoustic
	Urban
	Rave
	Latin
	Dance
	Hip Hop
	Rock
BASS	-14 to +14
MID	-14 to +14
TREBLE	-14 to +14
SUB	-14 to 0
FAD	Grid
BAL	Grid

NOTE: The EQ mode will automatically change to "USER" when individual audio functions are adjusted.

The Audio menu will automatically exit after a few seconds of inactivity. To exit quickly, touch the top left corner of the screen.

System Reset

To correct a system halt or other illegal operation, use the tip of a pen to press the reset button (2) located on the front bottom-left corner of the unit. After a system reset, the unit restores all factory default settings.



NOTE: If the unit is reset while a DVD is playing, the DVD resumes play once the reset is complete.

Steering Wheel Control (SWC)

The VM9224BT is compatible with the PAC (Pacific Accessory Corporation) steering wheel control adapter SWI-PS. A 3.5mm female connector (labeled "SWC Interface") on the back of the head unit allows connectivity to the PAC adapter. Please refer to the instructions included with the PAC adapter for detailed installation information.

SWC Functions

The following controls are available for most vehicles:

1. Vol Down
2. Vol Up
3. Mute
4. Seek Down / Previous Track / ** Preset Down
5. Seek Up / Next Track / ** Preset Up
6. SRC (Source)
7. ** Select
8. ** Select
9. Band

** If additional steering wheel control buttons are available on the vehicle, function 7 / 8 may be assigned the "Select" feature. This feature / function may not be available on some vehicles.

Select Operation

If "Select" (function 7 or 8) is held down and function 4 is pressed momentarily, Preset Up will be selected. If "Select" (function 7 or 8) is held down and function 5 is pressed momentarily, Preset Down will be selected.

Image/Display Settings

Video Output Modes

Table 2 shows the video output mode for each playing source.

Table 2: Video Output Modes

Playing Source	Video Output Modes
AM/FM TUNER	RGB Mode
DVD	RGB Mode
AUX IN	CVBS Mode

*CVBS – Composite Video Baseband Signal

Picture Adjustment

To adjust monitor display settings, perform the following steps:

1. *Press and hold* the **NAV** button (5) to access the "BRIGHT" setting. *Press and hold* twice to access the "CONTRAST" setting.
2. Turn the rotary encoder to adjust the setting level.
3. *Press and hold* the **NAV** button (5) again to exit the picture adjustment menu.

Parking Brake Inhibit

When the pink "Parking" wire is connected to the vehicle Parking Brake circuit, the front TFT monitor will display video when the Parking Brake is engaged. (When the pink wire is grounded via the Parking Brake circuit, video will be displayed.)

SETUP MENU

To access system settings, touch the  button on the screen to enter the “SETUP” menu. The “GENERAL” sub-menu appears highlighted in blue.

RADIO		SETUP MENU		05:33 AM
RDS	General	Language	Audio	Back
Bluetooth	Clock Mode		12Hr	▶
Rating	Clock		04 : 31	AM
Hardware	Tuner Region		USA	▶
P.VOL	Beep		On	▶
TS Cal				
DEMO				

Accessing Menu Items

Touch the sub-menu name to select a sub-menu (Language, Audio, RDS, etc.). The features available for adjustment under the highlighted sub-menu option will appear in the center of the screen.

Adjusting a Feature

1. Use the touchscreen to select the feature to be adjusted.
2. Enter the option field for the feature you want to adjust by using the touchscreen. A submenu appears in a second row with the selected option highlighted in blue.
3. Select a new value using the touchscreen.
4. Use the touchscreen to confirm setup.

General Sub-menu Features

Setting	Options	Function
Clock Mode	12Hr	Clock displays 12 hour time using AM and PM.
	24Hr	Clock displays 24 hour time up to 23:59.
Clock	(HH:MM)	Clock appears in the top right corner of the screen and on the LCD screen during certain operations. NOTE: The AM/PM indication will change as you continue to adjust the hour past 12.

Setting	Options	Function
Tuner Region	USA	<ul style="list-style-type: none"> • AM Frequency Spacing - 10kHz • AM Frequency Band - 530kHz~1720kHz • FM Frequency Spacing - 200kHz • FM Frequency Band - 87.5MHz~107.9MHz
	S.Amer1	<ul style="list-style-type: none"> • AM Frequency Spacing - 10kHz • AM Frequency Band - 530kHz~1720kHz • FM Frequency Spacing - 100kHz • FM Frequency Band - 87.5MHz~108.0MHz
	Arabia	<ul style="list-style-type: none"> • AM Frequency Spacing - 9kHz • AM Frequency Band - 531kHz~1620kHz • FM Frequency Spacing - 100kHz • FM Frequency Band - 87.5MHz~108.0MHz
	China	<ul style="list-style-type: none"> • AM Frequency Spacing - 9kHz • AM Frequency Band - 522kHz~1620kHz • FM Frequency Spacing - 100kHz • FM Frequency Band - 87.5MHz~108.0MHz
	S. Amer2	<ul style="list-style-type: none"> • AM Frequency Spacing - 5kHz • AM Frequency Band - 520kHz~1600kHz • FM Frequency Spacing - 100kHz • FM Frequency Band - 87.5MHz~108.0MHz
	Europe	<ul style="list-style-type: none"> • AM Frequency Spacing - 9kHz • AM Frequency Band - 522kHz~1620kHz • FM Frequency Spacing - 50kHz • FM Frequency Band - 87.5MHz~108.0MHz
	Korea	<ul style="list-style-type: none"> • AM Frequency Spacing - 9kHz • AM Frequency Band - 531kHz~1602kHz • FM Frequency Spacing - 200kHz • FM Frequency Band - 88.1MHz~107.9MHz
Beep	Off	No beep sounds
	On	When turned on, an audible beep tone confirms each function selection.

Language Sub-menu Features

If a DVD supports more than 1 Subtitle or Audio language, all the languages are available for selection during playback. If the selected language is not supported by the DVD, then the default language is used.

Setting	Options	Function
Language	English	On Screen Display appears in English.
Subtitle	English	DVD subtitles automatically appear in English when available.
	Auto	DVD subtitles appear according to the default subtitle language specified on the disc.
	Off	DVD subtitles do not appear.
Audio	English	DVD Audio is heard in English when the option is available.

Setting	Options	Function
DVD Menu	English	DVD menu (if applicable) is displayed in English.

Audio Sub-menu Features

Setting	Options	Function
DRC	Off	Employ the Dynamic Range Control for better playback for low volumes.
	On	
Loudness	Off	Turn bass boost on/off
	On	
Sub-woofer	Off	Turn the subwoofer on/off.
	On	
Sub Filter	80Hz	Selecting a crossover frequency sets a cut-off frequency of the subwoofer's LPF (low-pass filter).
	120Hz	
	160Hz	

RDS Sub-menu Features

Setting	Options	Function
RDS	Off	Turn On/Off RDS feature.
	On	
CT	Off	System time is synchronized with current broadcast station time (Clock Time). Setting this feature to On, will automatically set your system clock.
	On	

Bluetooth Sub-menu Features

Setting	Options	Function
Bluetooth	Off	Disable Bluetooth function.
	On	Enable Bluetooth function.
Connect	Manual	Connect the last active mobile phone by touching the CONNECT icon when disconnected.
	Auto	Automatically connect when your paired phone is in range.
Auto Answer	Manual	Manually answer calls by touching the "call" button.
	Auto	The unit automatically answers all incoming calls.
Pairing Code		The default code is "1234". Touch the keypad icon to open the keypad and enter the pairing code or pass key required for Bluetooth connection to your mobile phone. Not all phones/devices require a pairing code. The default code is "0000" for many models.

Rating Sub-menu Features

The DVD system has a built-in parental lock feature to prevent unauthorized persons from viewing restricted disc content. By default, the rating system is unlocked. Once setup, the parental lock is released only by entering the correct password. Once the password is entered, rating is available for setup.

Setting	Options	Function
Set Password	----	Enter a 4-digit password to activate the "Rating" feature.

Setting	Options	Function
Parental Ctrl	1. Kid Safe	Select the appropriate rating level for the intended audience. You may override higher ratings by using your password.
	2. G	
	3. PG	
	4. PG-13	
	5. PG-R	
	6. R	
	7. NC-17	
	8. Adult	
Load Factory	Reset	Select "Reset" to restore the factory default settings for the <i>Rating system only</i> .

To reset the password, access the "RATING" menu and enter the current password. Once the correct password is entered, you can access the "Password" field and enter a new one.

NOTE: Record the password and keep it in a safe place for future reference. The rating for each disc is marked on the disc, disc packing, or documentation. If the rating is not available on the disc, the parental lock feature is unavailable. Some discs restrict only portions of the disc, allowing the appropriate content will play. For details, please refer to the disc description.

Hardware Sub-menu Features

Setting	Options	Function
Camera In	Normal	
	Mirror	Reverse the camera image as if looking through a rear-view mirror.
Video Input (Input circuitry auto detects the video signal from the Aux In source).	NTSC	The color signals are output in the standard NTSC format.
	PAL	The color signals are output in the standard PAL format.
	Auto	The color signal output is switched automatically based on the current video input signal - NTSC or PAL.

If the monitor is in display mode, the monitor automatically switches to CAMERA mode upon reverse driving. When the reverse driving stops, the monitor return to its original input mode.

P.VOL Sub-menu Features

Setting	Options	Function
Source	RADIO	Choose a source for which you would like to increase the relative volume (LEVEL).
	DISC	
	USB1	
	USB2	
	SD	
	BT	
	NAV	
	AUX	
	CAMERA	
Level	0-6	Increase relative volume for specified source up to 6 decibels.

TS Cal (Screen Calibration)

To access the "Screen Calibration" function from the SETUP menu, select the "TS CAL" option.

After entering calibration mode, a crosshair + appears in a corner quadrant of the screen. To begin calibration, touch and hold the crosshair for one second until it moves to the next quadrant. Continue for each quadrant until the calibration is completed.

Demo Sub-Menu Features

You can stop/run demonstration mode or turn Demo Auto Run on/off by choosing the "Demo" option from the SETUP MENU.

When Demo "Auto Run" is Off, you can select "Demo > Run" to start Demo Mode. Demo scrolls through the various source screens, simulating activity on the display. "Demo" is discreetly displayed in blue text (below the clock), to indicate the unit is in Demo Mode. To stop Demo Mode, touch the upper-left quadrant of the TFT (Source select).

When Demo "Auto Run" is On, the unit will automatically display Demo Mode when powered on.

Exiting the System Setup Menu

To exit setup mode and resume normal playback, touch the **BACK** button on the screen.

TUNER OPERATION

Tuner TFT Display

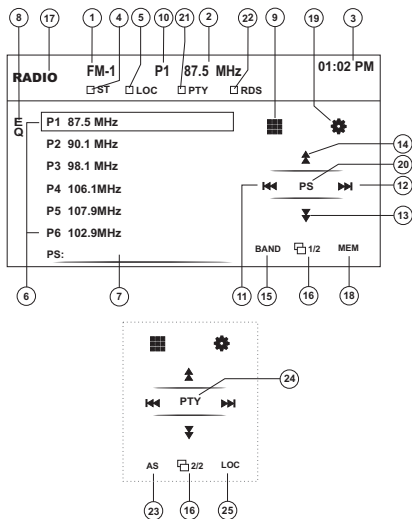

1. Current radio band indicator
2. Radio frequency indicator
3. Clock
4. Stereo broadcasting indicator
5. Strong Local signal broadcasting indicator
6. Preset radio stations: Touch to recall preset stations
7. Information about the current function
8. **EQ**: Touch for quick access to Equalizer level settings
9. : Touch to access the direct entry screen
10. Current preset station indicator
11. : Touch to seek backward
12. : Touch to seek forward
13. : Touch to tune backward one step
14. : Touch to tune forward one step
15. **BAND**: Touch to change between AM/FM bands

16. **1/2**: Touch to view a second screen of menu choices
17. Touch to view the SOURCE MENU and select a new playback source
18. **MEM**: View screen used to enter current channel into preset memory
19. : Touch to view the SETUP menu
20. **PS** (Preview Scan): Touch to scan all stations available, stopping for 5 seconds at each and continuing until a station is selected
21. PTY Indicator
22. RDS Indicator
23. **AS**: Touch to automatically store stations
24. **PTY**: Touch to activate the PTY function
25. **LOC**: Touch to activate/deactivate the Local function

Switching to Radio Tuner Source

- Touch the top left corner of the screen (the RADIO circle) to view the SOURCE MENU. Touch "Radio".
- Press the **SRC** button (4) on the front panel to switch to the AM/FM or RADIO source.

Selecting FM/AM Band

Touch the **BAND** button (15) on the screen to change between the following bands: FM1, FM2, FM3, AM1, and AM2.

NOTE: *The BAND button on the unit only works when the TFT is closed.*

Seek Tuning

To seek the next higher station, touch the **▶▶** button.

To seek the next lower station, touch the **◀◀** button.

Manual Tuning

To increase or decrease the tuning frequency one step, touch the **▶▶** or **◀◀** button.

Direct Tuning

To enter a radio station directly, touch the **MEM** button (9) to display the direct entry menu.

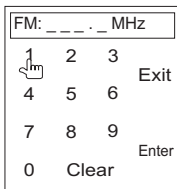

Enter the desired radio station using the on-screen number pad. Touch the **Enter** button to tune to the selected station. To exit the screen without changing the station, touch **Exit**. To clear your entry and start over, touch **Clear**.

Using Preset Stations

Six numbered preset buttons store and recall stations for each band. All six stored stations (P1-P6) for the current band appear on the screen.

Storing a Station

1. Select a band (if needed), then select a station.
2. Touch the on-screen **MEM** button (18) to open the preset screen.

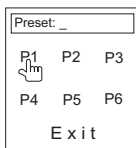

3. Touch the preset number in which you would like to store the current station (or touch **Exit** to cancel and close the menu). The preset number and station appear highlighted.

Recalling a Station

1. Select a band (if needed).
2. Touch an on-screen preset button (labeled P1 - P6) to select the corresponding stored station.

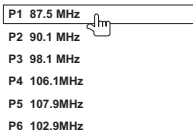

Auto Store/Preview Scan (AS/PS)

Auto Store (AS)

To select six strong stations and store them in the current band:

1. Select a band (if needed).
2. Touch the **AS** button (23) on page 2/2 of the on-screen controls to activate the Auto Store function.

The new stations replace stations already stored in that band.

Preview Scan (PS)

To scan the AM or FM band for a preview of available stations in your particular area, touch the **PS** button (20). Touch again to stop preview scan.

Local Radio Station Seeking (LOC)

When the Local function is on, only radio stations with a strong local radio signal are played. To activate the Local function in AM/FM tuner mode, *press and hold* the rotary encoder button (7) on the front panel. *Press and hold* the rotary encoder again to turn Local off. When the Local function is active, the LOC indicator at the top of the screen is illuminated.

DVD/VCD VIDEO OPERATION

NOTE: When properly installed, DVD video cannot be displayed on the main TFT screen unless the parking brake is applied. If you attempt to play a DVD while the vehicle is moving, the TFT screen displays "PARKING" with a blue background. Rear video screens, if applicable, will operate normally.

Inserting a Disc

Upon inserting a DVD disc, DVD mode is entered and disc play begins.

NOTE: If Parental Lock (Rating) is activated and the disc inserted is not authorized, the 4-digit code must be entered and/or the disc must be authorized (see "Rating Sub-menu Features" on page 14).

You cannot insert a disc if there is already a disc in the unit or if the power is off.

NOTE: DVD-R and DVD-RW will not play unless the recording session is finalized and the DVD is closed.

Ejecting a Disc

Press the **▲** button (3) on the front of the unit to eject the disc. The unit automatically reverts to Tuner mode. You may eject a disc with the unit powered off. The unit will remain off after the disc is ejected.

Resetting the Loading Mechanism

If the disc loads abnormally or an abnormal core mechanism operation occurs, *press and hold* the **▲** button (3) to reset the loading mechanism. Normal operation resumes.

Accessing DVD Mode

To switch to DVD mode when a disc is already inserted, press the **SRC** button (4) on the front panel.

Controlling Playback

To access the on-screen controls, touch the bottom 1/3 of the screen while a DVD is playing. Touch the **1/2** button to view a second page of controls

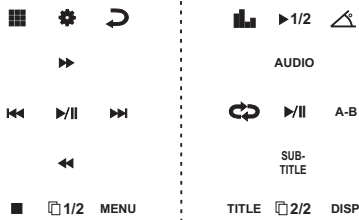

Stopping Playback

Touch the stop button (■) on the screen to stop DVD play.

Pausing Playback

Touch the play/pause button (▶/||) on the screen to suspend or resume disc play.

Slow Motion Playback (Forward and Reverse)

Touch the ▶1/2 button on the screen to play the current title in slow motion. Keep pressing and releasing the button to change the rate from forward 1/2, 1/4, 1/6 and 1/8 speed. Continue for slow motion backward at 1/2, 1/4, 1/6 and 1/8 speeds.

Touch the on-screen play button (▶/||) to resume normal play.

Fast Forward Playback

Touch the ▶▶ button on the screen to fast forward. Keep pressing and releasing the button to increase the rate from “x2” to “x4”, “x8”, and “x20”.

Touch the on-screen play button (▶/||) to resume normal play.

Fast Reverse Playback

Touch the ◀◀ button on the screen to fast reverse. Keep pressing and releasing the button to increase the rate from “x2” to “x4”, “x8”, and “x20”.

Touch the on-screen play button (▶/||) to resume normal play.

Repeat Playback

Touch the ↻ button to alter repeat mode according to the following:

- DVD: Repeat Chapter, Repeat Title, Repeat Off
- VCD (PBC Off): Repeat Single, Repeat Off

NOTE: For VCD play, the repeat function is not available if PBC is on.

Sectional Repeat Function (A-B)

Use the A-B function to define a specific area of a disc to repeat.

- Touch the **A-B** button on the second page of DVD on-screen controls to set the start point (A) of the repeated section.
- Touch the **A-B** button again once you reach the desired end point (B) of the repeated section. The selected portion of the DVD will now repeat continuously.
- Touch the **A-B** button a third time to cancel the A-B section setting and stop repeat play.

Accessing the DVD Menu

- Touch the **MENU** button on the first page of DVD on-screens controls to recall the main DVD menu. Touch to select a title from the menu.
- Touch the **TITLE** button on the second page of DVD on-screen controls to select a different title for playback.
- Select a title using the touch screen.

Moving Through Chapters

Touch the **▶▶|** button to advance to the next chapter on the DVD.

Touch the **|◀◀** button to move to the previous chapter.

Direct Chapter / Track Selection

To select a chapter/track directly, touch the on-screen  button to display the direct entry menu.

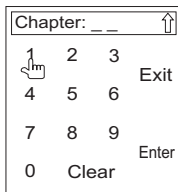

Enter the desired chapter/track using the on-screen number pad. Touch the **Enter** button to tune to the selected station. To exit the screen without changing the station, touch **Exit**. To clear your entry and start over, touch **Clear**.

Viewing an Alternate Picture Angle (DVD Only)

Some DVDs contain scenes that have been shot simultaneously from different angles. For discs recorded with multiple angles, touch the  button on the second page of DVD on-screen controls to toggle available angles of the on-screen image.

Multi-Language Discs (DVD Only)

Changing Audio Language

If you are watching a disc recorded in multiple languages, touch the **AUDIO** button on the second page of DVD on-screen controls to choose a language.

Changing Subtitle Language

If you are watching a disc recorded in multiple languages with subtitles, touch the **SUBTITLE** button on the second page of DVD on-screen controls to choose the language in which you would like the subtitles to appear.

NOTE: During VCD playback, touch the AUDIO button on the second page of DVD on-screen controls to choose between Left Channel, Right Channel, and Stereo.

PBC - Play Back Control (VCD Only)

For VCDs with play back functionality, play back control (PBC) provides additional controls for VCD playback.

Touch the **PBC** button on the first page of DVD on-screen controls to toggle the PBC function "On"/"Off". Once PBC is on, playback starts from track one of the play list.

NOTE: When PBC is activated, fast forward, slow playback, and previous/next track are available. Repeat and direct track selection are not available.

When PBC is activated, selecting random, scan, or search playback automatically deactivates PBC.

Playback Information

During DVD and VCD playback, touch the **DISP** button on the second page of DVD on-screen controls to display playback information on the screen, including the media playing and current playback time.

DVD Playback Information

- DVD Video – Format of current disc.
- Time 00:01:30/00:36:10 – Indicates the playback time of the current track.
- Title 5/08 – Indicates the fifth of 8 titles on the DVD is currently playing.

- Chapter 2/16 – Indicates that the second of 16 chapters on the DVD is currently playing.

VCD Playback Information

- VCD2.0 – Format of current disc.
- Time 00:01:30/00:36:10 – Indicates the playback time of the current track.
- PBC On/Off – Indicates whether Play Back Control is On or Off.

General Disc Information

Table 3: Disc Properties





Symbol	12cm Disc Properties	Max Play Time
 	Single side single layer (DVD-5) Single side double layer (DVD-9) Double side single layer (DVD-10) Double side double layer (DVD-18)	(MPEG 2 Method) 133 minutes 242 minutes 266 minutes 484 minutes
	Single side single layer (VCD)	(MPEG 1 Method) 74 minutes
	Single side single layer	74 minutes

Table 4: Disc Symbols





Symbol	Meaning
	Number of voice languages recorded. The number inside the icon indicates the number of languages on the disc (maximum of 8).
	Number of subtitle languages available on the disc (maximum of 32).
	Number of angles provided (maximum of 9).
	Aspect ratios available. "LB" stands for Letter Box and "PS" stands for Pan/Scan. In the example on the left, the 16:9 video can be converted to Letter Box video.

Table 4: Disc Symbols

Symbol	Meaning
	<p>Indicates the region code where the disc can be played.</p> <ul style="list-style-type: none"> • Region 1: USA, Canada, East Pacific Ocean Islands • Region 2: Japan, Western Europe, Northern Europe, Egypt, South Africa, Middle East • Region 3: Taiwan, Hong Kong, South Korea, Thailand, Indonesia, South-East Asia • Region 4: Australia, New Zealand, Middle and South America, South Pacific Ocean Islands/Oceania • Region 5: Russia, Mongolia, India, Middle Asia, Eastern Europe, North Korea, North Africa, North-West Asia • Region 6: Mainland China • ALL: All regions

DVD/CD AUDIO OPERATION

Instructions for TFT control and Insert/Eject are the same for DVD and CD operation. Please see the DVD/Disc Video Operation section for information about these topics.

The VM9224BT will play music or other audio files from the following disc media:

- CD-DA
- CD-R/RW
- DVD
- DVD+R/RW
- DVD-R/RW





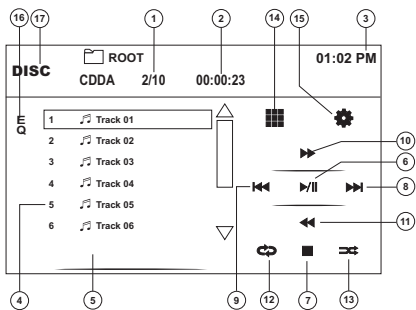

Upon inserting a disc with the TFT screen open, the disc and track title (if available), along with the track number and playing time, appear on the screen.

CD Player User Interface

The on-screen indicators and touch key areas for CD playback are outlined below.





1. Current track and total number of tracks on disc
2. Elapsed playing time
3. Current time
4. Track titles
5. Disc title
6. ▶/||: Touch to play/pause disc playback
7. ■: Touch to stop disc playback
8. ▶▶: Touch to move to next track

9. : Touch to move to previous track
10. : Touch to fast forward current track
11. : Touch to rewind current track
12. : Touch to activate/deactivate Repeat play mode
13. : Touch to activate/deactivate Random mode
14. : Touch to access the direct entry screen
15. : Touch to view the SETUP menu
16. **EQ**: Touch for quick access to Equalizer level settings
17. Touch to view the SOURCE MENU and select a new playback source

Controlling Playback

Stopping Playback

Touch the  button to stop disc play.

To resume playback, touch the  button.

Pausing Playback

Touch the  button to suspend or resume disc play.

Moving Through Tracks

Touch the  button to advance to the next track on the disc.

Touch the  button to move to the previous track.

Repeat Playback



Touch the  button to alter repeat mode according to the following:

- DVD: Repeat Chapter, Repeat Title, Repeat Off
- CDDA: Repeat Single, Repeat Folder, Repeat Off
- CD-R/RW: Repeat Single, Repeat Off
- DVD-R/RW: Repeat Single, Repeat Off

Track Scan Select (CD-DA discs only)

During disc play, touch the on-screen **SCAN** button to play the first 10 seconds of each track. When a desired track is reached, touch the **SCAN** button again to cancel the function and play the selected track.

Random Play Select

While disc play is stopped, touch the  button to play the tracks on the disc in a random, shuffled order. Touch the  (**RDM**) button again to cancel Random Play mode.



NOTE: CD-R and CD-RW will not play unless the recording session is finalized.

Fast Forward

Touch the ►► button to fast forward. Keep pressing and releasing the button to increase the rate from “x2” to “x4”, “x8”, and “x20”. Touch the ►|| button to resume normal playback.

Direct Track Entry

To select a track directly, touch the on-screen  button to display the direct entry menu.

Chapter: __			
1	2	3	Exit
	4	5	
4	5	6	Enter
7	8	9	
0	Clear		

Enter the desired track using the on-screen number pad. Touch the **Enter** button to tune to the selected station. To exit the screen without changing the station, touch **Exit**. To clear your entry and start over, touch **Clear**.

MP3/WMA OPERATION

Instructions for TFT control and Insert/Eject are the same for DVD and MP3 operation. Please see the DVD/Disc Video Operation section for information about these topics.

Media and File Requirements

This player allows you to play back MP3 and WMA files recorded onto CD-R/RWs, DVD+R/RWs, and DVD-R/RWs. For CD-RW discs, please make sure it is formatted using the full method and not the quick method to prevent illegal disc operation.

Up to 1500 songs/files can be burned onto a disc for a DVD music mix. Do not exceed this number of songs/files or disc readability problems may occur.

MP3 Format Compatibility

The file naming formats listed below are compatible with this unit:

- ISO 9660 – file name: 12 characters, file extension: 3 characters
- ISO 9660 – file name: 31 characters, file extension: 3 characters
- Joliet – 64 characters

If the file or folder name does not conform to ISO 9660 file system standards, it may not be displayed or played back correctly. Use the following settings when compressing audio data for your MP3 disc:

- Transfer Bit Rate: 128kbps
- Sampling Frequency: 48kHz

When recording MP3 up to the maximum disc capacity, disable additional writing. For recording on an empty disc up to maximum disc capacity, use the "Disc at once" setting.

MP3 Playing Order

When selected for play, files and folders (Folder Search, File Search or Folder Select) are accessed in the order they were written by the CD writer. As a result, the order in which they are expected to be played may not match the order in which they are actually played. You may be able to set the order in which MP3/WMA files are to be played by writing them onto a medium such as a CD-R with their file names beginning with play sequence numbers such as "01" to "99".

For example, a medium with the following folder/file hierarchy is subject to Folder Search, File Search or Folder Select, as shown below.

The VM9224BT player will only recognize three folder levels and does not display folders containing only other folders. In the example above, the unit will display folders 3, 4, 6, and 8, but not 2 and 7 since they do not contain any tracks directly. Folder 5 is not recognized at all since it is at the fourth level.

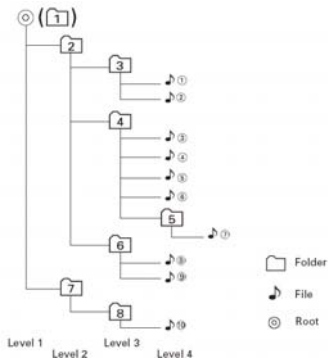

Inserting a USB Device or SD Card

NOTE: The USB port will recognize most USB flash memory devices and portable hard drives (hard drives must be formatted to FAT32 and NTFS is not supported).

1. Locate the USB/SD connector cover (8) on the front of the radio.

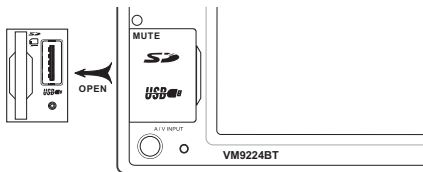

2. Lift the protective cover to reveal the connectors.
3. Insert the USB device or SD card into the appropriate connector. The unit will read the audio/video files automatically.





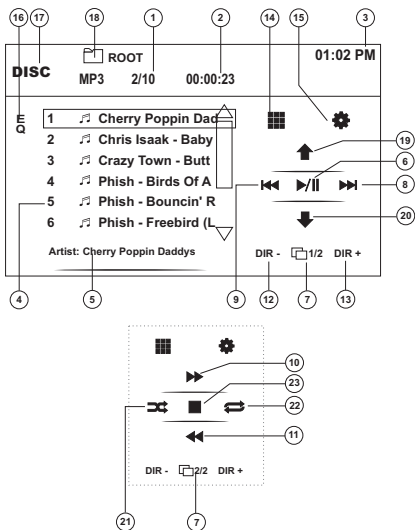

To remove the USB device or SD card, press the **SRC** button (4) or use the **SOURCE MENU** to switch to another mode, and then remove the device from the connector.

MP3 User Interface

The on-screen indicators and touch key areas for MP3 playback are outlined below.



1. Current track and total number of tracks on disc
2. Elapsed playing time
3. Current time
4. Track titles
5. ID3 information
6. ►/||: Touch to play/pause disc playback
7. 1/2, 2/2: Touch to move between page 1 and 2 of the on-screen controls
8. ►►: Touch to move to next track
9. ◀◀: Touch to move to previous track
10. ►►►: Touch to Fast Forward x2, x4, x8, x20
11. ◀◀◀: Touch to Fast Backward x2, x4, x8, x20
12. DIR -: Touch to view the previous folder
13. DIR +: Touch to view the next folder
14. ■■■: Touch to access the direct entry screen

15. : Touch to view the SETUP menu
16. **EQ**: Touch for quick access to Equalizer level settings
17. Touch to view the SOURCE MENU and select a new playback source
18. Folder name
19. : Page Up
20. : Page Down
21. : Random On > Random Off
22. : Repeat Single > Repeat Folder > Repeat Off
23. : Touch to stop disc playback

Controlling Playback

Playing MP3/WMA Files

After inserting a MP3/WMA disc, files will play in the sequence of the "Root" directory.

NOTE: When burning MP3 / WMA files onto a DVD disc, use the 2X or 4X burning option, if available. This slower burning speed will help eliminate buffer errors and increase disc reading reliability. Also, use folders when burning large numbers of songs / files to a disc for easy music navigation. Select the "Disc at Once" option and close your disc.

Stopping Playback

Touch the  button to stop disc play.

To resume playback, touch the  button.

Pausing Playback

Touch the  button to suspend or resume disc play.

Moving Through Tracks

Touch the  button to advance to the next track on the disc.

Touch the  button to move to the previous track.

Repeat Playback

Touch the  button to alter repeat mode according to the following: Repeat Single, Folder Repeat, Repeat Off.

NOTE: CD-R and CD-RW will not play unless the recording session is finalized.

Direct Track Entry

Touch the  button to access files directly (see "Direct Track Entry" on page 29).

iPod® OPERATION

NOTE: Be sure your iPod has the latest Apple firmware installed to avoid connectivity issues.

Accessing iPod Mode

This unit is Made for iPod® and iPhone®. You can control your iPod via touch screen to access Playlist, Artist, Album, Songs, etc. Supported models include, but are not limited to, the following:

- iPhone 4
- iPod nano 5G
- iPod touch 3G
- iPod classic

Accessing iPod Mode

The unit will automatically switch to iPod mode when an iPod or iPhone is plugged into the front or rear USB connector.

NOTE: For basic iPod connectivity, you can use the white 30-pin to USB iPod cable that came with your Apple device . For iPod video or photo playback, you must purchase the jLink-USB cable.

To return to the iPod menu from any other source menu, press the **SRC** button (4) on the front panel until the iPod menu appears on the screen, or choose the **iPod1** or **iPod2** icon from the "SOURCE MENU" (only available when an iPod or iPhone is connected to the USB1 or USB2 connector).

Indicators/Controls

The on-screen indicators and touch key areas for iPod playback are outlined below.

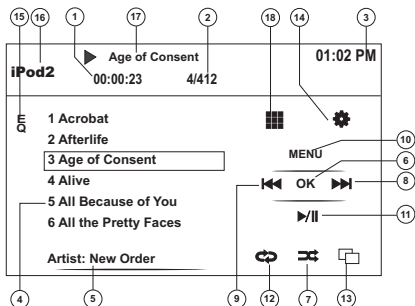

1. Elapsed playing time for current file
2. File number and total number of files on the disc
3. Current time
4. File titles
5. ID3 information (Artist/Album)
6. **OK**: Touch to "Enter"
7. **↻**: Touch to play all files in random order
8. **▶▶**: Touch to move to next file
9. **◀◀**: Touch to move to previous file
10. **MENU**: Touch to view the iPod main menu
11. **▶||**: Touch to play/pause disc playback
12. **↺**: Touch for Repeat File > Repeat Folder
13. Touch to view the album art screen
14. **⚙**: Touch to view the SETUP menu
15. **EQ**: Touch for quick access to Equalizer level settings
16. View SOURCE MENU and select a new source
17. Current file title
18. **■**: Touch to access the direct entry screen

Controlling your iPod

Touch the **MENU** button to access the main iPod menu. Use the touchscreen to navigate the iPod menus.

File Playback

To access files, touch the on-screen **MENU** button until you return to the main iPod menu and then select "MUSIC," "VIDEO" or "PHOTO."

- Touch the ►/|| button to play/pause.
- Touch the ►► button to move to the next item on the menu.
- Touch the ◀◀ button to move to the previous item on the menu.
- Use the touch screen to select the highlighted menu option.
- Touch the **MENU** button to return to the previous menu.

During music playback, the following screen is displayed:



- To return to the iPod music menu from the album art screen, touch ◀.
- To return to the Video or Photo menu while viewing video or photo, touch the screen.

Fast Forward/Fast Reverse

Touch and hold the ◀◀ or ►► button to fast forward or fast reverse. Release to resume normal play.

Direct Track Entry

To select a track directly, touch the on-screen button to display the direct entry menu.

Enter the desired track using the on-screen number pad. Touch **Enter** to play the selected file. To exit the screen without changing the file, touch **Exit**. To clear your entry and start over, touch **Clear**.

Track: _			
1	2	3	
4	5	6	Exit
7	8	9	
0	Clear		Enter

NOTE: To transmit the video from your iPod to the VM9224BT screen, you must set the following options through the iPod video settings menu: TV Out = On, TV Signal = NTSC, and Widescreen = On.

NOTE: After disconnecting your iPod, the VM9224BT will always return to the last mode accessed when the iPod is plugged back into the unit.

BLUETOOTH OPERATION

About Bluetooth

Bluetooth is a short-range wireless radio connectivity technology that is developed as a cable replacement for mobile phones, handheld PCs and other devices. Bluetooth operates in 2.4 GHz frequency range and transmits voice and data at speeds up to 1 megabit per second. Bluetooth was launched by a special interest group (SIG) comprised of Ericsson Inc., Intel Corp., Nokia Corp., Toshiba and IBM in 1998, and it is currently developed by nearly 2,000 companies worldwide. The Bluetooth word mark and logos are owned by the Bluetooth SIG, Inc. and any use of such marks by Audiovox Corporation is under license. Other trademarks and trade names are those of their respective owners.

NOTE: The line-of-sight distance between this unit and your cellular phone must be 8 meters or less for sending and receiving voice and data via Bluetooth wireless technology. However, the transmission distance may become shorter than the estimated distance, depending on the environment in use.

Please make sure your mobile phone supports Bluetooth functions (Headset or Handsfree profiles or both). Adhere to the following guidelines for successful operation.

- Before using Bluetooth functions, you must pair your mobile phone to the VM9224BT head unit (see "Pairing the Bluetooth System with Your Mobile Phone and Head Unit"). To ensure the best reception for pairing and re-connection, please make sure the phone battery is fully charged before you begin.
- Try to perform pairing within a few minutes of the phone being turned on.
- Once the unit has been paired with the phone, the unit's model number, "VM9224BT", will be displayed on the mobile phone.
- To achieve the best performance, always keep the mobile phone within 3 meters of the head unit.
- Always keep a clear path between the mobile phone and the head unit. Never place a metal object or any other obstacle between the mobile phone and the head unit.
- Some mobile phones (like Sony Ericsson) may have a "Power Saving Mode" option. PLEASE DO NOT use the power saving mode with the VM9224BT.
- Before accepting or making a call, make sure your mobile phone's "Bluetooth function" is turned on.
- To ensure the best conversation quality/performance, stay within one meter of the microphone when talking.







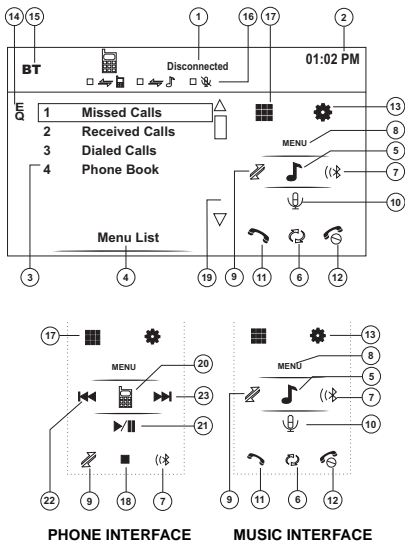



- To “disconnect” the mobile phone from the head unit, turn the Bluetooth connectivity off on the mobile phone or touch the button.
- Phone Book direct searching through the head unit is only available if the mobile phone supports Phone Book Download.** If the feature is not supported, the head unit will display “Phone book not provided by this phone” when an attempt is made to download a phone book.

Bluetooth User Interface

The on-screen indicators and touch key areas for Bluetooth operation are outlined below.



- Current connection status/device connected
- Current time
- Bluetooth menu
- Current operation status
- Toggle Music/Phone menu
- : Transfer active call back to handset
- : Pair your Bluetooth phone (first time use)

8. Exit call listing display
9. : Connect/disconnect Bluetooth device (phone, PDA, personal music player, etc.) with hand-free function
10. : Mute/un-mute microphone during active call
11. : Answer incoming call/make call
12. : Reject incoming call/end call/quit pairing process/quit reading phone book or call listing
13. : Touch to view the SETUP menu
14. **EQ**: Touch to view the equalizer
15. Touch to view the SOURCE MENU and select a new playback source
16. Status indicators (phone mode, music mode, mic mute)
17. : Touch to access the direct entry screen
18. : Touch to stop A2DP playback
19. Touch the scroll bar and arrows to view the previous/ next page of choices (only visible when needed)
20. Toggle Music/Phone menu/mode
21. : Play/Pause selected file
22. : Touch to move to the previous file
23. : Touch to move to the next file



Hands Free Profile (HFP)

To use a phone wirelessly with this unit, it is necessary to first establish a connection using Bluetooth wireless technology. Connection is normally established using HFP (Hands Free Profile), which gives you full control of functions available on the telephone source. However, depending on your phone, the connection may be made using HSP (Head Set Profile), making some functions unavailable. This is a limitation of your phone, not the VM9224BT.

Since there are a number of Bluetooth mobile phone implementations available on the market, operations with your Bluetooth mobile phone using this unit vary greatly.

Please refer to the instruction manual that came with your Bluetooth mobile phone along with this manual while operating your phone with this unit.

Pairing the Bluetooth System with Your Mobile Phone and Head Unit

1. Touch the  button (7) to initiate the pairing process. Keep the mobile phone within 2 meters of the head unit when pairing. (To terminate the pairing process, touch the  button again.)

2. Select the Bluetooth setup option on the mobile phone to be paired (please refer to the phone's instruction manual to learn how to enter Bluetooth setup, turn Bluetooth on/off, and perform pairing).

NOTE: Some phones require a "pass key" or pairing code to connect. If your phone requires a pass key or pairing code, you will need to enter this number in the Pairing Code field under the Bluetooth SETUP menu. The default pairing code for many phones is "0000". The default code for the VM9224BT is "1234". See "Bluetooth Sub-menu Features" on page 14 for instructions on entering the pairing code.

3. Select "VM9224BT" from the pairing list on the mobile phone.
 - If pairing is successful, the TFT will display the paired mobile phone model number or name (as specified in your phone's Bluetooth Setup menu).
 - If pairing fails, "Phone Pairing Fail" is displayed at the bottom of the screen.

Reconnecting

Once the Bluetooth device has been paired, you can touch the connect  button (9) to reconnect.

NOTE: You can only connect to a phone using the buttons on the on-screen Phone interface.

Each time the  button is touched, the head unit will automatically reconnect with the mobile phone once (only if the mobile phone was previously paired with the head unit).

Managing Incoming Calls

When connected to a Bluetooth phone, the unit will mute audio output, pause CD play, and change to the Bluetooth screen when a call is received. An incoming phone number will appear at the top of the screen.

Answering an Incoming Call

To answer the call, touch the  button (11).

For best reception, speak loudly and clearly.

To end the conversation, touch the  button (12). The screen will display the call duration for 3 seconds, and then return to the previous mode.

Rejecting an Incoming Call

Touch the  button to reject an incoming call. The call will revert to your phone and can be answered directly or left for voice mail.

Volume Control

To increase or decrease the volume level, turn the rotary encoder (7) on the front panel.

Microphone Mute

To mute the microphone, touch the button (10). Touch again to resume microphone functionality.

Making an Outgoing Call

NOTE: Touch the button from the main Bluetooth screen to automatically dial the last call received.

1. Touch the button to open the direct dial screen.

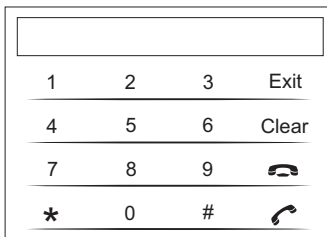

2. Use the 0-9, *, and # buttons to input the phone number.
 - Touch the **CLEAR** button to clear the last digit.
 - Touch the button to clear the entire number and start over.
3. After entering the phone number, touch the button to dial the call. The direct dial screen will close once your call is connected.

To end the conversation, touch the button.

Call Transfer

While talking, to transfer audio from the head unit back to the mobile phone, touch the button (6). The TFT will display "Transfer". You can only transfer a call after it has been answered.

Menu List

The menu list appears on the left side of the screen and can be accessed from other modes by touching the **MENU** button on the right side of the screen.

NOTE: Not all phones allow access to missed, received or dialed calls and some will not allow uploading of your phone's address book.

Missed Calls

The Missed Calls list retrieves the list of Missed numbers from your phone. The last missed number is the first number on the list. Touch the Missed Calls menu option to view the list. To make a call from the Missed Calls list, touch the number and then touch the  button. The TFT will display "Cannot get missed record" when the feature is not available.

Dialed Calls

The Dialed Calls list retrieves the list of dialed numbers from your phone. The last dialed number is the first number on the list. Touch the Dialed Calls menu option to view the list. To make a call from the Dialed Calls list, touch the number and then touch the  button. The TFT will display "Cannot get dialed record" when the feature is not available.

Received Calls

Use the Received Calls list to view the last 10 received numbers stored on your phone. To access the Received list, touch the Received Calls menu option. The last received number is the first number on the list. To make a call from the Received Calls list, touch the number and then touch the  button. The TFT will display "Cannot get received record" when the feature is not available.

Phone Book

1. Touch the Phone Book menu option to display the phone book stored on your mobile phone, if compatible. The screen will display "Ready..." while the phone book is downloading.
2. Once the download is completed, you can use the arrow buttons and scroll bar on the right side of the window to navigate the list. Since the unit downloads one page of entries at a time, there may be a slight delay while the next page of numbers is downloaded.
3. Touch to highlight the number you want to dial and then touch the  button.

NOTE: Some mobile phones do not support Phone Book upload through Bluetooth. This is a limitation of the phone, not the VM9224BT.

Bluetooth Setup

Auto Answer

You can choose to have the VM9224BT automatically answer incoming calls to your paired Bluetooth phone. To turn “Auto answer” on:

1. Touch the  button to view the SETUP menu.
2. Select the “Bluetooth” sub-menu.
3. Touch the area to the right of “Auto answer” to select “Auto”.

Auto Connect

The auto Connect option will allow the VM9224BT to automatically connect to your previously paired Bluetooth when it is in range. When the Connect option is set to “Manual”, you must touch the  button to re-establish a connection with your phone. To turn auto “Connect” on:

1. Touch the  button to view the SETUP menu.
2. Select the “Bluetooth” sub-menu.
3. Touch the area to the right of “Connect” to select “Auto”.

Advanced Audio Distribution Profile (A2DP)

The VM9224BT allows you to play back audio files from your phone, PDA or personal music player using a Bluetooth connection.

Before using an audio player, it may be necessary to enter a PIN code into the unit. Enter the PIN code referring to “Bluetooth Sub-menu Features” on page 14.

NOTE: Please quit A2DP mode before attempting to make a phone call, as unexpected results may occur depending on your mobile phone model.

The VM9224BT can control a Bluetooth audio player via Advanced Audio Distribution Profile (A2DP) or Audio/Video Remote Control Profile (AVRCP). Bluetooth audio players (or Bluetooth adapters) compatible with these profiles can be connected to this unit. Functionality varies depending on the profile used.

TROUBLESHOOTING

Table 5: Troubleshooting

Problem	Cause	Corrective Action
GENERAL		
Unit will not power on	Radio Fuse blown	Install new fuse with correct rating
	Car battery fuse blown	Install new fuse with correct rating
	Illegal operation	Press the RESET button located in the bottom left corner of the front panel
No/low audio output	Improper audio output connection	Check wiring and correct
	Volume set too low	Increase volume level
	Improper "MUTE" connection	Review wiring diagram and check "MUTE" connection
	Speakers damaged	Replace speakers
	Heavily biased volume balance	Adjust the channel balance to the center position
	Speaker wiring is in contact with metal part of car	Insulate all speaker wiring connections
Poor sound quality or distortion	Pirated disc is in use	Use original copy
	Speaker power rating not compatible with unit	Connect proper speakers
	Speaker is shorted	Check speaker contact
Unit resets itself when engine is off	Incorrect connection between ACC and positive battery wire	Check wiring and correct
TFT MONITOR		
No image	Incorrect connection to parking brake wire	Check wiring and correct
	Parking brake is not engaged	Stop vehicle in safe place and apply parking brake
Flashing image or interference appears on screen	DVD is not compatible with current TV system settings	Change setup to accommodate disc
	Improper video signal connections	Check wiring and correct
Prolonged image or improper height/width ratio display	Improper aspect ratio setup	Use correct aspect ratio setting
TUNER		

Table 5: Troubleshooting

Problem	Cause	Corrective Action
Weak station searching	Auto antenna is not fully extended	Connect the auto antenna control cable properly
	Auto antenna not properly connected	Connect the auto antenna control cable properly
	LOCAL function is activated	Turn LOCAL function off
Cannot insert disc	Disc already inside unit	Eject current disc and insert new one
Image blurred, distorted, or dark	Disc is illegally copied	Use original disc
Disc does not play back	Disc is warped or scratched	Use disc in good condition
	Disc is dirty or wet	Clean disc with soft cloth
	Laser pickup is dirty	Clean laser pickup with cleaning disc
	Incompatible disc is used	Use compatible disc
	Disc rating exceeds Parental Lock rating limit	Change Parental Lock settings to lower restriction
	Disc region code is not compatible with unit	Use disc with proper region code
	Disc is inserted upside down	Insert disc with label side up
PBC cannot be used during VCD playback	PCB is not available on the disc	
No repeat or searching while playing VCD	PCB is on	Turn PCB off
MP3		
Interruption occurred during playback	Disc is dirty or scratched	Clean disc or replace
	File is damaged/bad recording	Recreate disc with good files

Error Messages

Table 6: Error Messages

Message Displayed	Cause	Corrective Action
Loading	Disc is being read	

Table 6: Error Messages

Message Displayed	Cause	Corrective Action
No Disc	Disc is dirty	Clean disc with soft cloth
	Disc is upside down	Insert disc with label side up
	Disc not present in loading compartment	Insert disc
Bad Disc	Disc is dirty	Clean disc with soft cloth
	Disc is upside down	Insert disc with label side up
Unknown disc	Disc format is not compatible with this unit	
Region Error	DVD is not compatible with region code of unit	
Error	Illegal mechanism operation	Press the EJECT key for 5 seconds to reset the loading mechanism

Care and Maintenance

1. Use only a clean silicone cloth and neutral detergent to clean the front panel or monitor. A rough cloth and non-neutral detergent (such as alcohol) may result in scratching or discoloration.
2. Do not get water or cleaning fluids on the unit.
3. If the temperature inside the player gets too hot, a protective circuit automatically stops play of the disc. If this occurs, allow the unit to cool before operating the player again.
4. Never insert anything other than a 5" (12 cm) compact disc into the player as the mechanism can be damaged by foreign objects.
5. Do not attempt to use a 3" (8 cm) CD-Single disc in this unit, either with or without an adaptor, as damage to the player and/or disc may occur. Such damage is not covered by the Warranty on this product.
6. The CD player may not operate properly in extreme hot or cold. If such conditions occur, allow the interior of the vehicle to reach a normal temperature before using player.
7. When the vehicle warms up during cold weather or under damp conditions, condensation may appear on the LCD panel. Should this occur, the screen will not operate properly until the moisture has evaporated.
8. We suggest you use a cleaning disc in this unit more frequently than in the unit in your home due to the environmental conditions of the vehicle.

SPECIFICATIONS

DVD/CD Player

Compatible Disc Media: DVD \pm R / RW (Single and Dual Layer) and CD-R / RW

Compatible Media Formats: CD-DA, MP3, WMA, VCD, SVCD, Xvid, AVI, MPEG1 / 2

Signal to Noise Ratio: > 95dBA

Dynamic Range: > 95dB

Frequency Response: 20Hz to 20 kHz, -3dB

Channel Separation: > 60dB @ 1 kHz

D/A Converter: High performance 24-bit / 192 kHz sample rate, Multi-Bit Sigma-Delta Modulator

Video

Format: NTSC, PAL (auto-detection)

Output: 1Vp-p (75-ohm)

Input: 1Vp-p (75-ohm)

FM Tuner

Tuning Range: 87.5MHz - 107.9MHz

Mono Sensitivity (-30dB): 9dBf

Quieting Sensitivity (-50dB): 15dBf

Alternate Channel Selectivity: 70dB

Signal to Noise Ratio @ 1 kHz: 58dB

Image Rejection: 80dB

Stereo Separation @ 1 kHz: > 30dB

Frequency Response: 30Hz - 15 kHz, -3dB

AM Tuner

Tuning Range: 530 kHz - 1720 kHz

Sensitivity (-20dB): 15uV

Signal to Noise Ratio @ 1 kHz: 50dB

Image Rejection: 60dB

Frequency Response: 50Hz - 2 kHz, -3dB

Monitor

Screen Size: 6.2" (Measured diagonally), 16:9 Widescreen

Screen Type: High Definition TFT Liquid Crystal Display (LCD)

Resolution: 1,152,000 sub pixels, 800x3 (W) X 480 (H)

General

Auxiliary Input impedance: 10k

Power Supply: 11 to 16VDC, negative ground

Power Antenna (Blue): 500mA max, current limited protection

Amplifier Remote (Blue/White): 500mA max, current limited protection

Operating Temperature: -20C ~ 65C

Fuse: 15-amp, mini ATM type

DIN chassis dimensions: 7" X 7" X 4" (178mm x 178mm x 50mm)

CEA Power Ratings



Power Output: 13 Watts RMS x 4 channels into 4-Ohms @ \leq 1% THD+N

Signal to Noise Ratio: 70dBA below reference (Reference: 1 Watt, 4-Ohms)

Frequency Response: 20 Hz - 20 kHz, -3dB. (Aux Input used as reference input)

Reference Supply Voltage: 14.4VDC

**Specifications subject to change without notice.*



Audiovox Electronics Corporation
Hauppauge, NY 11788
Technical Assistance: 1-800-323-4815
www.jensen.com

© 2011 Audiovox
Ver. 011711
Printed in China