



CDR5620

**6.2" 2 DIN CAPACITIVE TOUCH SCREEN
MULTIMEDIA DVD RECEIVER**

**AM-FM-RDS
USB/microSD Multimedia Player
Front & Rear Camera Inputs**

**INSTALLATION &
OWNER'S MANUAL**



JENSEN®

Copyright and Trademark

SD Logo is a trademark of SD-3C, LLC.

The Bluetooth® word mark and logos are registered trademarks owned by Bluetooth SIG Inc.

Other trademarks and trade names are those of their respective owners.

All rights reserved. No part of this publication may be reproduced, distributed, or transmitted in any form or by any means, including photocopying, recording, or other electronic or mechanical methods, without the prior written permission of Namsung America Inc.

©2020 Namsung America Inc.

FCC Compliance

This device complies with Part 15 of the FCC Rules. Operation is subject to the following two conditions:

- (1) this device may not cause harmful interference, and
- (2) this device must accept any interference received, including interference that may cause undesired operation.

Warning: Changes or modifications to this unit not expressly approved by the party responsible for compliance could void the user's authority to operate the equipment.

Note: This equipment has been tested and found to comply with the limits for a Class B digital device, pursuant to Part 15 of the FCC Rules. These limits are designed to provide reasonable protection against harmful interference in a residential installation. This equipment generates, uses and can radiate radio frequency energy and, if not installed and used in accordance with the instructions, may cause harmful interference to radio communications. However, there is no guarantee that interference will not occur in a particular installation. If this equipment does cause harmful interference to radio or television reception, which can be determined by turning the equipment off and on, the user is encouraged to try to correct the interference by one or more of the following measures:

- Reorient or relocate the receiving antenna.
- Increase the separation between the equipment and receiver.
- Connect the equipment into an outlet on a circuit different from that to which the receiver is connected.
- Consult the dealer or an experienced radio/TV technician for help.

Safety Notice

Video / movie playback will not operate while the vehicle is moving. This is a safety feature to prevent driver distraction. In-dash video / movie functions will only operate when vehicle is in Park and the parking brake is engaged. It is illegal in most jurisdictions for the driver to view video while the vehicle is in motion.



The **SAFETY NOTICE** is reminder to drive responsibly and safely while using your mobile phone device, or any APP's that are compatible with this unit.

it is highly recommended that your JENSEN CDR5620 is installed by a professional installer or an authorized dealer.

This product is only for use in vehicles with 12VDC negative ground only.

To prevent damage or injury:

- Make sure to ground the unit securely to the vehicle chassis ground.
- Do not remove the top or bottom covers of the unit.
- Do not install the unit in a spot exposed to direct sunlight or excessive heat or the possibility of water splashing.
- Do not subject the unit to excessive shock.
- When replacing a fuse, only use a new one with the correct rating. Using a fuse with the wrong rating may cause the unit to malfunction.
- To prevent short circuits when replacing a fuse, disconnect the wiring harness first.
- Use only the provided hardware and wire harness.
- If you experience problems during installation, consult your nearest JENSEN dealer.
- If the unit malfunctions, reset the unit as described. If the problem still persists, consult your nearest JENSEN dealer or call tech assistance @ 1-888-921-4088.
- To clean the monitor, wipe only with a dry silicone cloth or soft cloth. Do not use a stiff cloth, or solvents such as paint thinner and alcohol. They can scratch the surface of the panel and/or remove the printing.
- When the temperature of the unit falls (as in winter), the liquid crystal inside the screen will become darker than usual. Normal brightness will return after the unit is in use for a while.
- When extending the ignition, battery or ground wiring, make sure to use automotive-grade wiring with an a minimum AWG 16 or more to prevent voltage drops.
- Do not touch the liquid crystal fluid if the LCD is damaged or broken. The liquid crystal fluid may be hazardous to your health or fatal. If the liquid crystal fluid from the LCD contacts your body or clothing, wash it off with soap immediately.

JENSEN

CDR5620 INSTALLATION

Preparation

Please read and understand entire manual before installation.

Consult a qualified technician for detailed instructions or installation assistance.

Before You Start

- Disconnect negative battery terminal.
- Avoid installing the unit where it would be subject to high temperatures, such as from direct sunlight, or where it would be subject to dust, dirt or excessive vibration.

Getting Started

- Unpack unit from its protective packaging.
- Connect vehicle wiring harness and antenna to this receivers harness. See wiring instructions. Consult a qualified technician if you are unsure.
- Certain vehicles may require an installation dash kit and/or wiring harness adapter (sold separately).
- Reconnect battery negative terminal.
- Test for correct operation and secure back into dashboard.
- Snap trim ring into place if needed.

Tools Required

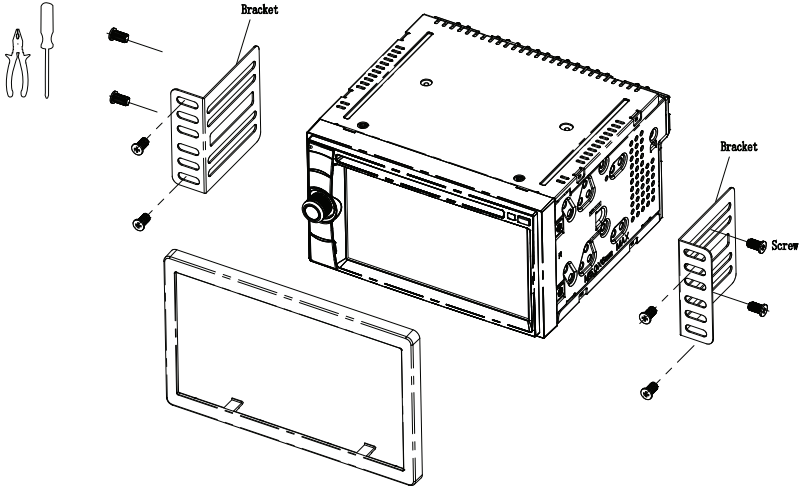

Typical ISO-DIN Installation

Input / Output Wiring Diagram

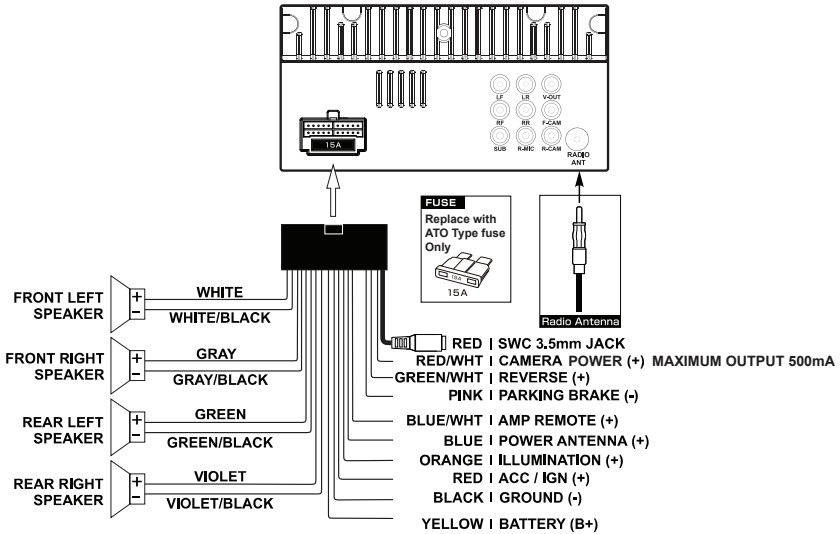

💡 Tips

When replacing a fuse, make sure to use the correct type and amperage. Using an incorrect fuse could cause damage. The unit uses (1) 15 amp ATO blade-type fuse located on the back of the unit.

Front / Rear camera inputs

Up to two cameras (not included) can be used. We recommend JENSEN Part # BUCAM200J for front camera and BUCAM300AJ or BUCAM400AJ for rear camera.

JENSEN

CDR5620 OPERATION

Getting Started - First Time Setup Wizard

The first time the unit is powered ON, the *SETUP WIZARD* will help guide you through the main radio system settings and connect to your Bluetooth Device.

STEP 1

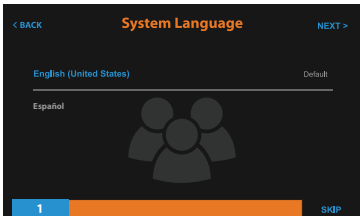

Select Language

STEP 2

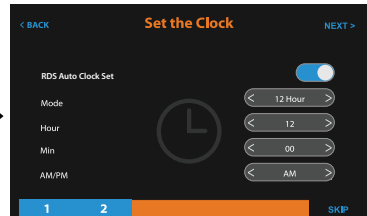

Set the Clock

STEP 3

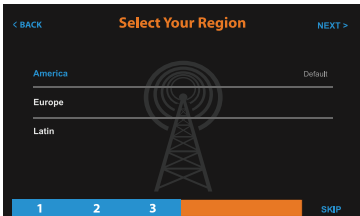

Set Radio Region

STEP 4

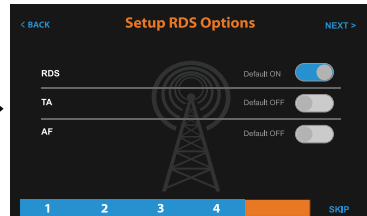

Set RDS Functions

STEP 5



Auto Store Presets

STEP 6

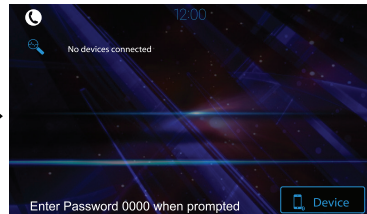

Pair Bluetooth

Select **JENSEN BT** then enter **PASSCODE 0000** on your Device

 **Tips** The *SETUP WIZARD* can be skipped at any time.

To rerun the *SETUP WIZARD* again, long press **RESET** button with a paperclip for 3 seconds, or go to **ABOUT** section in *SETUP*, select **SETUP WIZARD**

Main Control Locations



- Voice Control** ① Press to activate the voice assistant feature.
- Source Menu** ② Press SRC to access available modes: Radio, Bluetooth Phone, Bluetooth Audio, Disc, USB, SD Card, Auxiliary Input, Rear Camera and Settings.
- Power** ③ Press and hold to turn the unit off. Press any button to turn the unit on.
- Volume** ③ Rotate to increase or decrease volume levels.
- Mute** ③ Press to silence the audio. Press again to return to the previously selected volume. Rotating the volume knob while muted will also cancel the mute function.
- Reset** ④ To reset all settings to the factory default, use a paper clip to press the reset button (located behind the door on the front panel) for three seconds.
- Auxiliary Input** ⑤ Connect external audio/video devices to the RCA auxiliary input located behind the door on the front panel.
- microSD Card** ⑥ Insert a microSD card into the microSD slot (located behind the door on the front panel) to play MP3 audio files.
- USB** ⑦ Connect a USB device to play MP3 audio files use as a charging port to charge your device.
- Eject** ⑧ Press to eject a disc from the disc slot.

Main Menu Operation

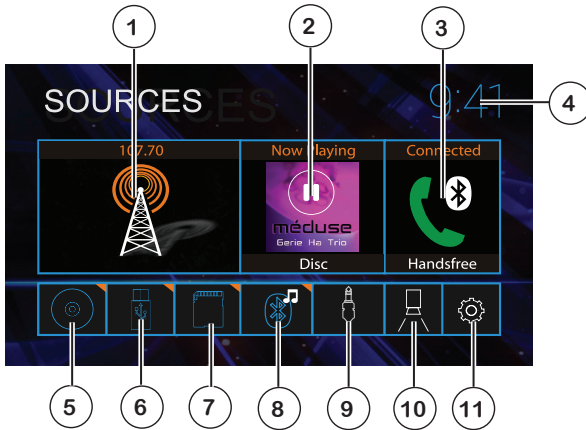

- Radio ①** Press to access Radio.
- Media Player ②** Press to access Media Player.
- BT Handfree Calling ③** Press to access BT handsfree calling.
- Standby Mode ④** Press to put the unit in standby mode.
Press anywhere on the screen to return to the previous mode.
- Disc ⑤** Press to access Disc.
- USB ⑥** Press to access USB.
- microSD Card ⑦** Press to access microSD Card.
- BT Music ⑧** Press to access BT Music.
- Auxiliary Input ⑨** Press to access Auxiliary Input.
- Camera ⑩** Press to access the Front or Rear Camera.
- Settings Menu ⑪** Press to access Settings menu.

Settings Menu

From the Main Menu, press the gear icon to access the Settings menu and adjust General, Clock, Audio, Bluetooth, Display or About options.

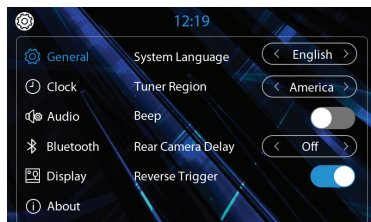

General:

- **Language** - Select English or Spanish.
- **Tuner Region** - Select America, Europe or Latin America.
- **Beep** - Enable or disable the audible beep.
- **Rear Camera Delay** - Select desired delay for rear camera: .5 seconds, 2 seconds, 3 seconds or Off (no delay).
- **Reverse Trigger** - Select On or Off for the reverse trigger feature.
- **Rear Camera Image** - Select Normal or 180 display of the rear camera image.

Clock:

- **Mode** - Select between 12-hour and 24-hour clock display.
- **Hour** - Set the hour for the clock display.
- **Min** - Set the minute for the clock display.
- **AM/PM** - Set AM or PM for the clock display.

Audio:

- **Camera Audio** - Turn the rear camera audio On or Off.
- **Audio Level** - Set audio levels (-7 to 7) for each audio source: Tuner, USB, SD Card and Bluetooth Handsfree.

Bluetooth:

- **Bluetooth** - Turn Bluetooth signal on or off.
- **Auto Connect** - Turn auto connect feature on or off.
- **Auto Answer** - Turn auto answer feature on or off.
- **PIN** - Change the Bluetooth PIN (default is 0000).
- **Name** - Displays the device name (JENSEN BT).

Display:

- **Illumination Trigger** - Turn the illumination trigger On or Off.
- **Brightness Day** - Adjust daytime brightness level (1 to 10).
- **Gamma Day** - Adjust daytime gamma level (-4 to 4).
- **Wallpaper** - Select one of four available wallpaper options.
- **Contrast** - Adjust contrast level (-4 to 4).
- **Hue** - Adjust hue (-4 to 4).

About:

- **Screen Calibration** - Press to calibrate the touch screen.
- **Version** - Press to display version numbers.
- **System Reset** - Press to restore unit to default factory settings.
- **Setup Wizard** - Press to initiate the system Setup Wizard.
- **EULA** - Select On or Off.

Tuner Operation



Main Menu ① Press to return to the main menu.

Preset Stations ② Press any preset button to play the corresponding preset station. Press and hold to save the current station as a preset.

AM Bands ③ Press to select between 2 AM bands.
Note: The 6 preset buttons will reflect the 6 stations stored in the current band.

FM Bands ④ Press to select between 3 FM bands.
Note: The 6 preset buttons will reflect the 6 stations stored in the current band.

Bluetooth Phone ⑤ Press to access the Bluetooth phone.

Stereo / Mono ⑥ Press to toggle between Stereo and Mono tuning. This feature can also be adjusted using the ST/MONO icon under the preset buttons.

AS/PS ⑦ Press briefly to scan preset stations in the current band and listen to each for 5 seconds. Press again to stop scanning and listen to the current station. Press and hold to automatically search and save the strongest stations in the current band as presets.

Direct Station Access ⑧ Press to display the number pad and tune to a station by directly entering the station number.

Station Search ⑨ Press to search for the next strong station.

Audio ⑩ Press to display and adjust the following audio options:

1. EQ - Choose a preset EQ option (Classic, Rock, Pop, Jazz or Flat) or manually adjust equalization curves.
2. Loudness
3. Balance / Fader
4. Subwoofer

Tuner Operation

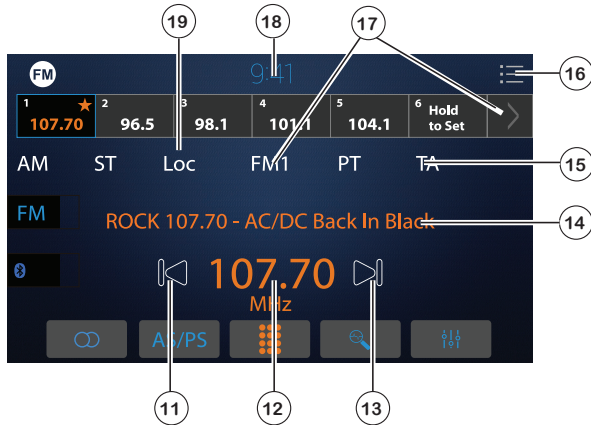

- Tune Down** (11) Press automatically seek the last strong station. Press and hold to enter manual tuning mode, then press to tune down one step at a time.
- Station Number** (12) Displays the current station number.
- Tune Up** (13) Press automatically seek the next strong station. Press and hold to enter manual tuning mode, then press to tune up one step at a time.
- Station Information** (14) Displays available station information.
- RDS Alerts** (15) Displays available RDS information alerts.
- RDS Setup Menu** (16) Access and adjust options in the RDS setup menu.
- Band** (17) Use either option to step through 2 AM and 3 FM bands.
- Standby** (18) Press to put the unit in standby mode. Press anywhere on the screen to return to the previous mode.
- Local / Distance** (19) Press to toggle between Local and Distance tuning options.

Media Player Operation

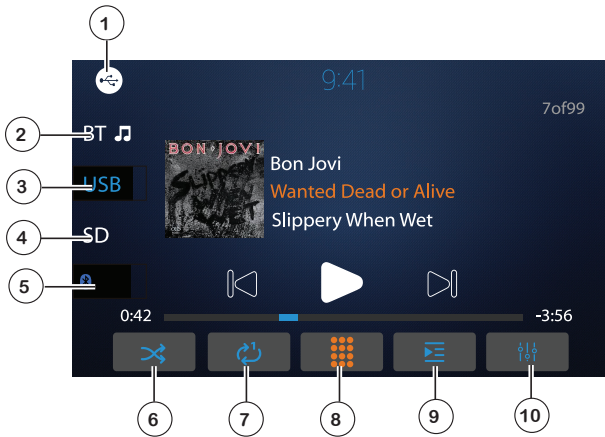

Media Player

To play audio files from a disc, USB device or microSD card, insert disc or device and playback will begin automatically. To return to disc, USB or microSD card playback from another mode of operation, select the corresponding icon from the Main Menu.

- Main Menu** (1) Press to return to the main menu.
- Bluetooth Music** (2) Press to begin playback of Bluetooth Music.
- USB** (3) Press to begin playback from USB device.
- microSD** (4) Press to begin playback from microSD card.
- Bluetooth Phone** (5) Press to access the Bluetooth phone.
- Random** (6) Press to turn random playback on or off.
- Repeat** (7) Press to select one of the following repeat options: Repeat 1, Repeat All or Repeat Off.
- Direct File Access** (8) Press to display the number pad and tune to a file by directly entering the file number.
- File Search** (9) Press to display the file search menu:
 1. Select the desired file type (audio, photo or video).
 2. Search by folder, then select the desired file name to begin playback.
- Audio** (10) Press to display and adjust the following audio options:
 1. EQ - Choose a preset EQ option (Classic, Rock, Pop, Jazz or Flat) or manually adjust equalization curves.
 2. Loudness
 3. Balance / Fader
 4. Subwoofer

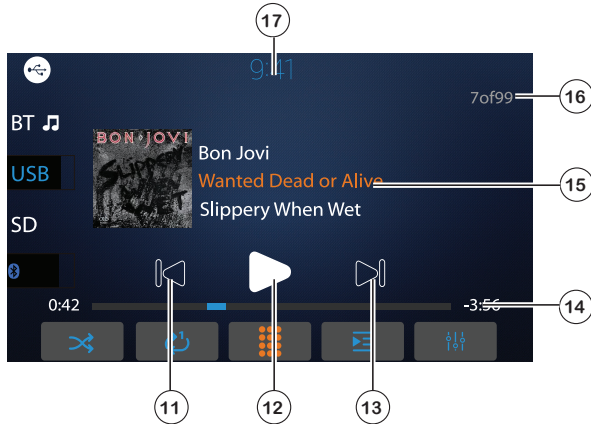

- Tune Down / Fast Reverse** (11) Press to return to the beginning of the current track. Press again to return to the previous track. Press and hold to fast reverse the current track.
- Play/Pause** (12) Press to pause playback. Press again to resume.
- Tune Up / Fast Forward** (13) Press to return to the beginning of the current track. Press again to return to the previous track. Press and hold to fast reverse the current track.
- Track Time** (14) Displays elapsed and total time for the current track.
- Track Information** (15) Displays any available information for the current track, including track name, artist name, album name and album art.
- Track Number** (16) Displays the current track number and total number of tracks.
- Standby** (17) Press to put the unit in standby mode. Press anywhere on the screen to return to the previous mode.

Media Compatibility

File Type		MP3	
File System	FAT	FAT 12	X
		FAT 16/FAT 32	✓
File Extension	.mp3/.MP3/.Mp3/.mp3		✓
	.rmp/.m4a		X
MPEG Format	MPEG 1		✓
	MPEG 2		✓
	MPEG 2.5		✓
Sampling Frequency	MPEG 1		32/44.1/48kHz
	MPEG 2		12/16/22.05/24kHz
	MPEG 2.5		8/11.025/12kHz
Bitrate	MPEG 1		32 ~ 320kbps
	MPEG 2		8 ~ 160kbps
	MPEG 2.5		8 ~ 160kbps
Other Information	Directory Depth		Unlimited
	File Name Length		32 bytes
	Total File Number		2000 files
	Total Folder Number		200 folders
	File Number via Folder		2000 files
	MP3 ID3 TAG	ver.1.x	
ver.2.x		✓	
Title, Artist, Album		✓	

Media Compatibility

The following types of files are not compatible:

- MP3 PRO format, MP3 playlists
- RMP format
- WAV format
- WMV format
- AAC, protected AAC, M4A format

Playback Order

MP3 playback sequence begins in the root folder of the USB flash drive or microSD card. Any folders that do not include MP3 files are skipped.

Compatible Recording Formats

ISO9660 standards:

- Maximum nested folder depth is 8 (including the root folder).
- Valid characters for folder/file names are letters A-Z (all caps), numbers 0-9, and “_” (underscore). Some characters may not be displayed correctly, depending on the character type.

Notes

Some files may not play, depending on sampling rates and bit rates. For best results, use the following settings when ripping MP3 files: 128kbps or higher constant bit rate; 44.1kHz or higher sampling frequency

Bluetooth - Handsfree Operation

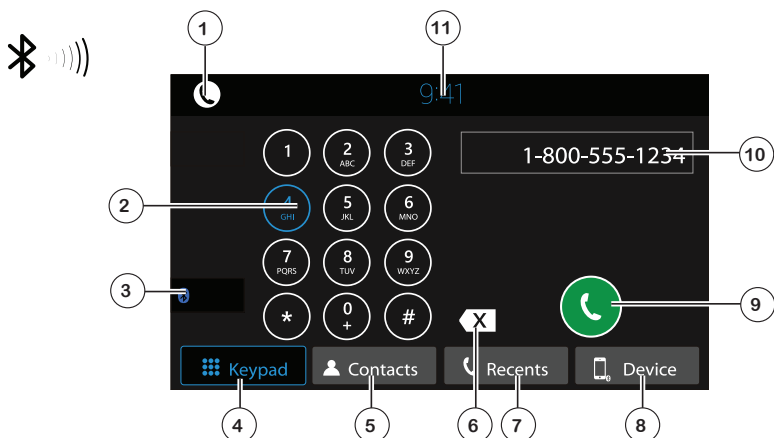

Preparation

Before you can use a Bluetooth device, it must be paired and connected. Make sure that Bluetooth is activated on your device before you begin the pairing process.

Pairing a New Device

Complete the pairing sequence from your Bluetooth device. The unit name is "JENSEN BT". The Bluetooth passcode is "0000". The unit can be in any mode of operation when pairing is performed. On certain phones, pairing may need to be done more than once.

Connecting a Paired Device

Most Bluetooth devices will connect automatically if the device is in range when the unit is powered-on. If your device was previously paired but does not connect, enter the Bluetooth setup menu and turn Auto Connect on.

Bluetooth Phone

To access the phone, select Bluetooth Phone from the Main Menu or press the phone icon from any operational mode.

Main Menu ①

Press to return to the main menu.

Keypad ②

Use the keypad to dial a phone number.

Last Source ③

Press to return to the last audio source.

Display Keypad ④

Press to display the keypad.

Contacts ⑤

Press to display contact list.

Backspace ⑥

Press to backspace when using the keypad.

Recents ⑦

Press to display a list of recent calls.

Device List ⑧

Press to display a list of paired devices, then press the desired device name to connect.

Talk ⑨

After entering a phone number, press to connect a call.

Phone Number ⑩

Displays the phone number entered using the keypad.

Standby ⑪

Press to put the unit in standby mode. Press anywhere on the screen to return to the previous mode.

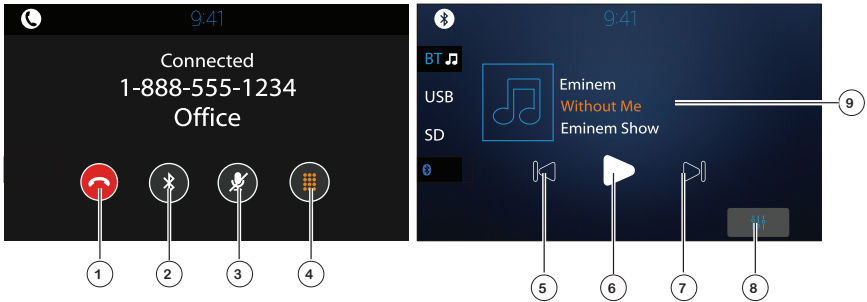

Calling Options

End call (1)

Transfer audio (2)

Mute (3)

Display Keypad (4)

Bluetooth Music

Previous Track (5)

Play / Pause (6)

Next Track (7)

Audio (8)

Track Information (9)

Use the following options during a phone call:

Press to end a phone call.

Press to transfer call audio between head unit and mobile phone.

Press to mute the microphone during a call.

Press to display the keypad during a call.

Use the following options to control playback during Bluetooth Music operation:

Press to return to the previous track.

Press to pause playback. Press again to resume.

Press to advance to the next track.

Press to display and adjust the following audio options:

1. EQ - Choose a preset EQ option (Classic, Rock, Pop, Jazz or Flat) or manually adjust equalization curves.

2. Loudness

3. Balance / Fader

4. Subwoofer

Displays any available information for the current track, including track name, artist name and album name.

Rear Camera

Connect an optional rear camera to the Rear Camera inputs (Yellow RCA connector for video and Black RCA connector for audio). Refer to the wiring diagram for details.

Manual selection - Touch the Camera icon from the Main Menu. Touch the camera icon on the top left area on the screen to exit camera mode.

Note: The unit will automatically select REAR camera mode when connected to the reverse circuit.

Note: External video output is not active when using the rear camera input.

Front Camera

Connect an optional front camera to the Front Camera inputs (Yellow RCA connector for video; there is no audio connection for a front camera. Refer to the wiring diagram for details.

To access the front camera, touch the Camera icon in the Main Menu. The unit displays rear camera by default.

Press the Reverse Camera icon in the top right corner to switch to front camera view.

Auxiliary Input

Connect an optional audio source into the auxiliary input behind the door on the front panel.

Select the auxiliary input icon from the Main Menu to listen to audio.

Adjust volume on the external audio source as needed (if connected to the headphone output of the device).

JENSEN

CDR5620 OPTIONS

Steering Wheel Controls

A third-party adapter must be used in order for the CDR5620 to be compatible with any OEM steering wheel controls.

The CDR5620 has a built-in 3.5mm SWC interface that compatible with many popular 3rd party SWC control modules, such as PAC, METRA, and others.

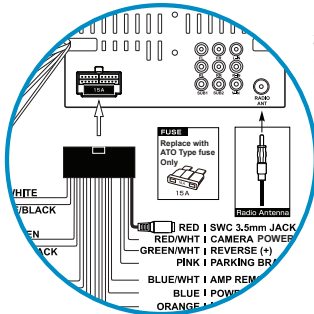

3.5mm SWC port located on the rear of the unit, on the MAIN POWER I/O Harness

The following controls are available for most vehicles.

- Volume +
- Volume -
- Mute
- Seek / Track +
- Seek / Track -
- Band
- Mode
- BT Talk
- BT End Call

Note: Not all OE steering wheel functions may be supported by the CDR5620

We recommend the PAC SWI-RC .

1. Set "Radio Select Switch". Set the SWI-RC to position 7 - "Pioneer/Other/Sony".
2. To program, use the Pioneer/Sony/Other radio function mapping order.
3. When programming the SWI-RC, if a function is not supported (or not desired), then the function MUST be skipped as per the PAC SWI-RC instructions.
4. The SWC function MUST be programmed in the correct order per the PAC SWI-RC radio function mapping order instructions.

Limited One Year Warranty

This warranty gives you specific legal rights. You may also have other rights which vary from state to state.

Namsung America Inc. warrants this product to the original purchaser to be free from defects in material and workmanship for a period of one year from the date of the original purchase.

Namsung America Inc. agrees, at our option, during the warranty period, to repair any defect in material or workmanship or to furnish an equal new, renewed or comparable product (whichever is deemed necessary) in exchange without charges, subject to verification of the defect or malfunction and proof of the date of purchase. Subsequent replacement products are warranted for the balance of the original warranty period.

Who is covered?

This warranty is extended to the original retail purchaser for products purchased from an authorized Jensen dealer and used in the U.S.A.

What is covered?

This warranty covers all defects in material and workmanship in this product. The following are not covered: software, installation/removal costs, damage resulting from accident, misuse, abuse, neglect, product modification, improper installation, incorrect line voltage, unauthorized repair or failure to follow instructions supplied with the product, or damage occurring during return shipment of the product. Specific license conditions and copyright notices for the software can be found via www.jensenmobile.com

What to do?

1. Before you call for service, check the troubleshooting guide in your owner's manual. A slight adjustment of any custom controls may save you a service call.
2. If you require service during the warranty period, you must carefully pack the product (preferably in the original package) and ship it by prepaid transportation with a copy of the original receipt from the retailer to an authorized service center.
3. Please describe your problem in writing and include your name, a return UPS shipping address (P.O. Box not acceptable), and a daytime phone number with your shipment.
4. For more information and for the location of the nearest authorized service center please contact us by one of the following methods:

- Call us toll-free at 1-888-921-4088
- E-mail us at cs@dualav.com

Exclusion of Certain Damages: This warranty is exclusive and in lieu of any and all other warranties, expressed or implied, including without limitation the implied warranties of merchantability and fitness for a particular purpose and any obligation, liability, right, claim or remedy in contract or tort, whether or not arising from the company's negligence, actual or imputed. No person or representative is authorized to assume for the company any other liability in connection with the sale of this product. In no event shall the company be liable for indirect, incidental or consequential damages.

JENSEN

CDR5620 GENERAL

Trouble Shooting

General		
PROBLEM	CAUSE	ACTION
Unit will not turn on (no power)	Red and/or Yellow wire not connected or incorrect voltage	Check connections for proper voltage (11~16VDC)
	Black wire not connected	Check ground connection
	Blown fuse on unit or vehicle	Replace fuse(s)
Unit has power (but no sound)	Speaker wires not connected	Check all connections, including speakers
	Speakers are blown	Replace speakers
	One or more speaker wires touching each other or touching chassis ground	Insulate all bare speaker wires from each other and chassis ground
Unit blows fuse(s)	Yellow or red wire touching chassis ground	Check for pinched or shorted wires
	Speaker wires touching chassis ground	Check for pinched or shorted wires
	Incorrect fuse rating	Use fuse with correct rating
Unit has audio (but no video)	Parking brake safety circuit not connected Parking brake not applied	Check connections at parking brake Apply parking brake as described in manual
	Video Playback Codec is not supported	See Media Codec Support section

Customer Support

1-888-921-4088

(Monday-Friday, 9AM-5PM EST)

Visit <https://www.jensenmobile.com>

For Your Records

Please keep your original sales receipt and be prepared to provide this receipt in the event you require service, as your original receipt is considered the best proof of purchase and indicates the date you purchased your JENSEN product.

Dealer Info

Dealer Name: _____

Dealer Phone: _____

Purchase Date: _____

Specifications

FM Tuner

US Tuning Range: 87.5MHz-107.9MHz
EU Tuning Range: 87.50MHz-108.00MHz
Usable Sensitivity: 8.5dBf
50dB Quieting Sensitivity: 10dBf
Stereo Separation@ 1kHz: 30dB
Frequency Response: 30Hz-13kHz

AM Tuner

Tuning Range: 530kHz-1710kHz
Usable Sensitivity: <42dBu
Frequency Response: 30Hz-2.2kHz

Bluetooth

Version: 4.1 + EDR
Profiles: HFP / A2DP / PBAP
Range: Up to 33ft / 10m

Monitor

Brightness: 400 nit
TFT Resolution: 800x480
TFT Backlighting: LED
Touch Screen Type: Resistive

General Specifications

Operation Voltage Input: 11~16VDC
USB 1 Charge Output: 1.0
USB 2 Charge Output: 1.0A
Speaker Nominal Impedance: 4~8 ohms
Line Output Voltage: 4 Volts RMS
Dimensions: 5" x 7" x 4" (126D x 178W x 101H mm)



CEA-2006 Power Standard Specifications

(reference: 14.4VDC +/- 0.2V, 20Hz~20kHz)

Power Output: 16 Watts RMS x 4 channels at 4 ohms and $\leq 1\%$ THD+N
Signal to Noise Ratio: 80dBA (reference: 1 watt into 4 ohms)

CDR5620

INSTALLATION & OWNER'S MANUAL



Customer Support

1-888-921-4088

(Monday-Friday, 9AM-5PM EST)

Visit <https://www.jensenmobile.com>

Designed and Engineered in USA

JENSEN®

Namsung America Inc.
©2020 Namsung America Inc.
All rights reserved.

All rights reserved. No part of this publication may be reproduced, distributed, or transmitted in any form or by any means, including photocopying, recording, or other electronic or mechanical methods, without the prior written permission of NAMSUNG AMERICA INC.

NSA0320-v01
Printed in China