



VX3528

QUICK START GUIDE

Multimedia DVD Receiver with Bluetooth and SiriusXM-Ready™ featuring 6.2" Touch Screen Display

This Quick Start Guide gives you the basics to start using your VX3528. Please visit www.jensenmobile.com to download a complete owner's manual or call customer service at 1-888-921-4088 (Monday-Friday, 9AM-5PM EST).

JENSEN

Customer Service Toll Free: 1-888-921-4088

Safety Notes:

The DVD video display of the in-dash unit will not operate while the vehicle is moving. This is a safety feature to prevent driver distraction. In-dash DVD video functions will only operate when vehicle is in Park and the parking brake is engaged. It is illegal in most states for the driver to view video while the vehicle is in motion.

Installation

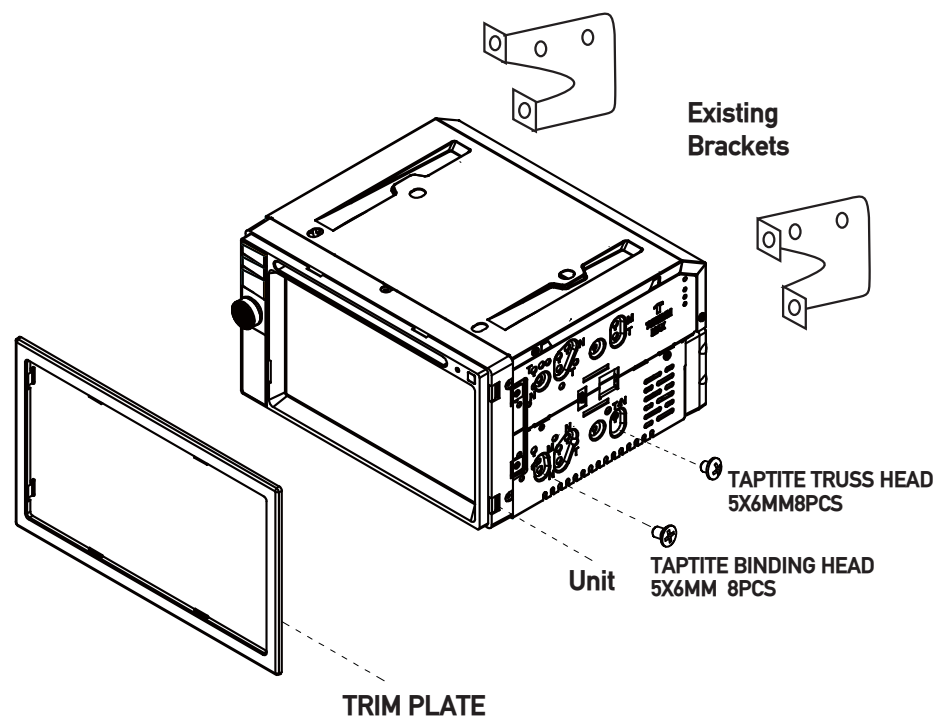

Note:

Using the existing brackets or the brackets supplied with the installation kit, mount the brackets to the sides of the head unit with the screws supplied with the head unit.

Copyright and Trademark Notes

This product incorporates copyright protection technology that is protected by method claims of certain U.S. patents and other intellectual property rights owned by Macrovision Corporation and other rights owners. Use of this copyright protection technology must be authorized by Macrovision Corporation, and is intended for home and other limited viewing uses only unless otherwise authorized by Macrovision Corporation. Reverse engineering or disassembly is prohibited. DVD Logo is a trademark of DVD Format/Logo Licensing Corporation registered in the U.S., Japan and other countries. iPod and iPhone are trademarks of Apple Inc., registered in the U.S. and other countries. Dual Electronics Corporation is not affiliated with Apple, Inc. Sirius, XM and all related marks and logos are trademarks of Sirius XM Radio, Inc. All rights reserved. The Bluetooth® word mark and logos are owned by the Bluetooth SIG, Inc. Other trademarks and trade names are those of their respective owners.

Wiring Diagram - Inputs/Outputs

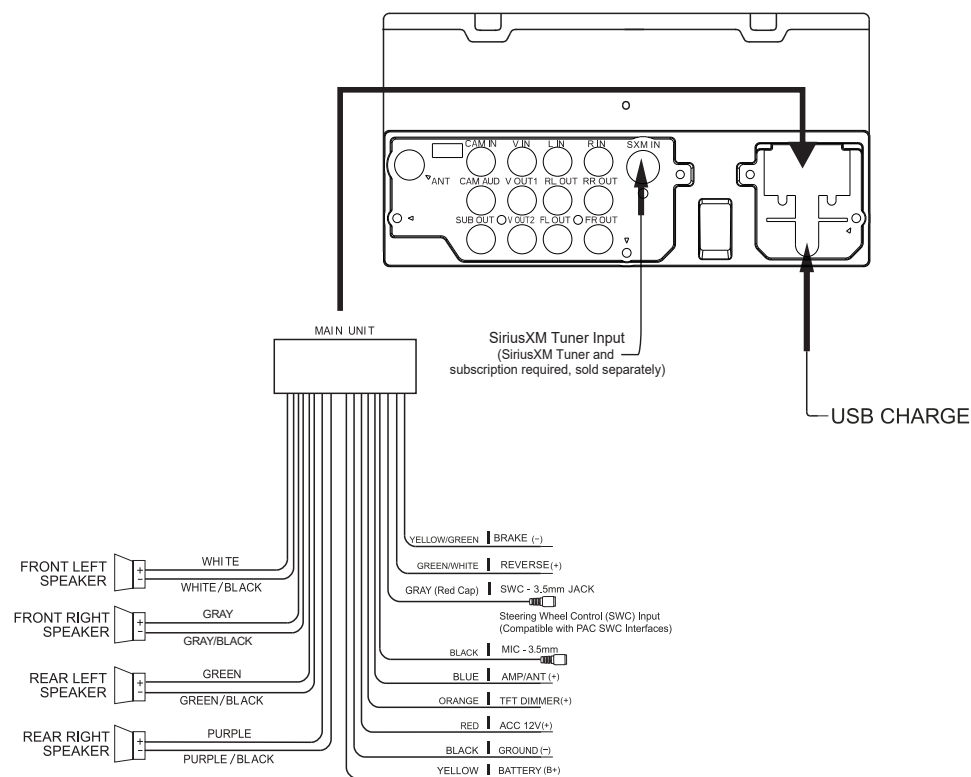

Control Locations



- | | | |
|-----------|--------------------------------|-----------------|
| 1. Eject | 4. Power / Volume / Mute | 7. Reset Button |
| 2. EQ | 5. Additional Inputs (USB, AV) | 8. Disc Slot |
| 3. Source | 6. IR Remote Sensor | |

Remote Control

- | | |
|----------------------|---------------------|
| 1. Power/Mute | 11. Subtitle |
| 2. Eject | 12. Menu |
| 3. Play/Pause | 13. Random |
| 4. Tune / Track Down | 14. Volume Down |
| 5. Previous | 15. PTT |
| 6. EQ | 16. Volume Up |
| 7. Repeat | 17. Tune / Track Up |
| 8. Display | 18. Band |
| 9. Audio | 19. AS/PS |
| 10. Source | 20. Next |

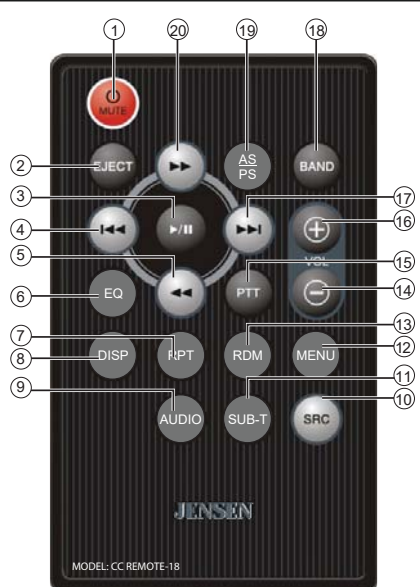

Main Menu

From any operational mode, press the arrow icon in the top left corner to access the Main Menu screen. Use the right and left arrows in the bottom corners to navigate between the two Main Menu screen, and touch any icon to directly access the corresponding mode.



General Operation

From the Main Menu screen, press Settings in the bottom right corners to access the Setup Menu and select from the following categories: General, Time, Display, Panel, Disc, Radio, Bluetooth, SXM, Illumination, Wallpaper and Version.



Radio Operation

Select the Radio icon from the Main Menu screen

- | | |
|---------------------------|------------------------|
| 1. Main Menu | 8. Manually Tune Down |
| 2. Current Mode Indicator | 9. Seek Tune Up |
| 3. Current Frequency | 10. Manually Tune Up |
| 4. Source | 11. Additional Options |
| 5. Band | 12. Preset Stations |
| 6. Seek Tune Down | |
| 7. Auto Store | |



DVD Operation

- | | |
|---------------------------|-----------------------|
| 1. Main Menu | 8. Next Chapter |
| 2. Current Mode Indicator | 9. Additional Options |
| 3. Elapsed Time | 10. Repeat |
| 4. Source | 11. Random |
| 5. Stop | 12. Direct Entry |
| 6. Previous Chapter | 13. Menu |
| 7. Play/Pause | 14. Angle |

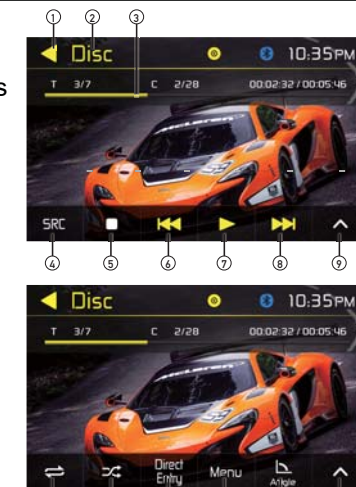

CD / USB Operations

Insert a disc (label facing up) and playback will begin automatically. To switch to CD mode from another mode of operation when a disc is already inserted, select the Disc icon from the Main Menu screen.

- | | |
|---------------------------|------------------------|
| 1. Main Menu | 6. Previous Track |
| 2. Current Mode Indicator | 7. Elapsed Time |
| 3. File Information | 8. Play/Pause |
| 4. Source | 9. Next Track |
| 5. List | 10. Additional Options |



iPod® Operation

The unit will automatically switch to iPod® mode when an iPod® or iPhone® is plugged into the front panel USB connector. iPod® mode can be accessed from the Main Menu by touching the iPod® icon (only available when an iPod® or iPhone® is connected).

- | | |
|---------------------------|------------------------|
| 1. Main Menu | 8. Play/Pause |
| 2. Current Mode Indicator | 9. Next File |
| 3. File Information | 10. Additional Options |
| 4. Source | 11. Repeat |
| 5. List | 12. Random |
| 6. Elapsed Time | 13. Direct Entry |
| 7. Previous File | 14. EQ |



Pandora Operation

Once you install the Pandora the Pandora app from the Apple iTunes store on to your iPod® or iPhone®, and connect it to the unit via USB cable, Pandora music will begin to play.

- | | |
|---------------------------|------------------------|
| 1. Main Menu | 8. Play/Pause |
| 2. Current Mode Indicator | 9. Next File |
| 3. File Information | 10. Additional Options |
| 4. Source | 11. Thumb Up |
| 5. List | 12. Thumb Down |
| 6. Elapsed Time | 13. Bookmark Track |
| 7. Previous File | 14. Bookmark Artist |

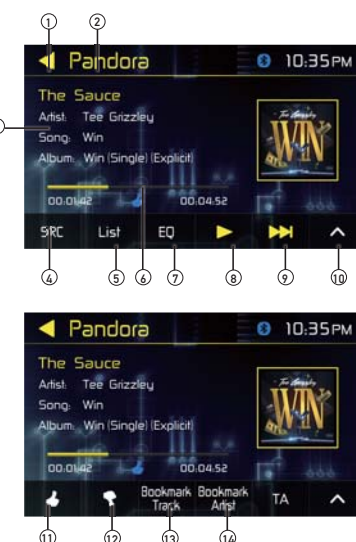

SiriusXM Operation

- | | |
|---------------------------|---------------------------|
| 1. Main Menu | 10. Band |
| 2. Current Mode Indicator | 11. Preset Memory |
| 3. File Information | 12. Channel Scan |
| 4. Source | 13. Channel Lock/Unlock |
| 5. List | 14. Direct Channel Access |
| 6. Previous | |
| 7. Channel/Category | |
| 8. Next | |
| 9. Additional Options | |

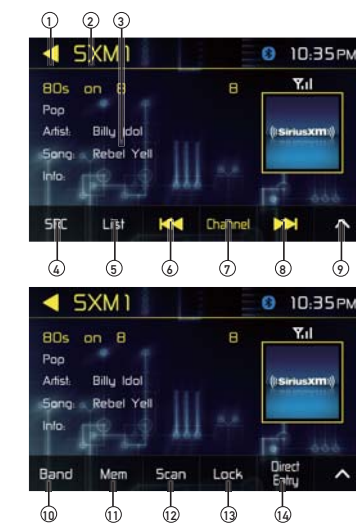

Bluetooth Operation

Bluetooth Microphone

The external microphone should be mounted in a high clear area, pointed directly at the driver seat.

Pairing and Connecting

Before using Bluetooth functions, you must pair your mobile phone to the VX3528 unit. The device name is "Jensen". The Bluetooth passcode "5309". To ensure the best reception for pairing and re-connection, please make sure the mobile phone battery is fully charged before you begin.

Dialing a Number

Press # to display keypad and dial a number.



Making and Ending a Call

Press to connect a call, and press to end a call.

Transferring Audio

Press to transfer audio between the head unit and mobile phone.

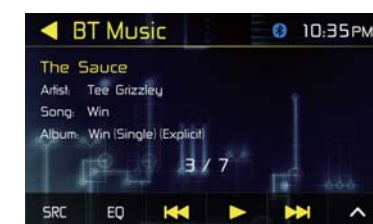

Streaming Audio

Press to play or pause the music. Press to skip to the previous track. Press to advance to the next track.

One-Year Limited Warranty

This warranty gives you specific legal rights. You may also have other rights which vary from state to state. Dual Electronics Corp. warrants this product to the original purchaser to be free from defects in material and workmanship for a period of one year from the date of the original purchase. Dual Electronics Corp. agrees, at our option, during the warranty period, to repair any defect in material or workmanship or to furnish an equal new, renewed or comparable product (whichever is deemed necessary) in exchange without charges, subject to verification of the defect or malfunction and proof of the date of purchase. Subsequent replacement products are warranted for the balance of the original warranty period. Who is covered? This warranty is extended to the original retail purchaser for products purchased from an authorized Dual dealer and used in the U.S.A. What is covered? This warranty covers all defects in material and workmanship in this product. The following are not covered: software, installation/removal costs, damage resulting from accident, misuse, abuse, neglect, product modification, improper installation, incorrect line voltage, unauthorized repair or failure to follow instructions supplied with the product, or damage occurring during return shipment of the product. Specific license conditions and copyright notices for the software can be found via www.dualav.com.

What to do?

- Before you call for service, check the troubleshooting guide in your owner's manual. A slight adjustment of any custom controls may save you a service call.
- If you require service during the warranty period, you must carefully pack the product (preferably in the original package) and ship it by prepaid transportation with a copy of the original receipt from the retailer to an authorized service center.
- Please describe your problem in writing and include your name, a return UPS shipping address (P.O. Box not acceptable), and a daytime phone number with your shipment.
- For more information and for the location of the nearest authorized service center please contact us by one of the following methods:

- Call us toll-free at 1-888-921-4088 (Monday-Friday, 9:00 a.m. to 5:00 p.m. EST)
- E-mail us at cs@dualav.com

Exclusion of Certain Damages: This warranty is exclusive and in lieu of any and all other warranties, expressed or implied, including without limitation the implied warranties of merchantability and fitness for a particular purpose and any obligation, liability, right, claim or remedy in contract or tort, whether or not arising from the company's negligence, actual or imputed. No person or representative is authorized to assume for the company any other liability in connection with the sale of this product. In no event shall the company be liable for indirect, incidental or consequential damages.

FCC Compliance

This device complies with Part 15 of the FCC Rules. Operation is subject to the following two conditions:

- (1) this device may not cause harmful interference, and
- (2) this device must accept any interference received, including interference that may cause undesired operation.

Warning: Changes or modifications to this unit not expressly approved by the party responsible for compliance could void the user's authority to operate the equipment. **Note:** This equipment has been tested and found to comply with the limits for a Class B digital device, pursuant to Part 15 of the FCC Rules. These limits are designed to provide reasonable protection against harmful interference in a residential installation. This equipment generates, uses and can radiate radio frequency energy and, if not installed and used in accordance with the instructions, may cause harmful interference to radio communications. However, there is no guarantee that interference will not occur in a particular installation. If this equipment does cause harmful interference to radio or television reception, which can be determined by turning the equipment off and on, the user is encouraged to try to correct the interference by one or more of the following measures:

- Reorient or relocate the receiving antenna.
- Increase the separation between the equipment and receiver.
- Connect the equipment into an outlet on a circuit different from that to which the receiver is connected.
- Consult the dealer or an experienced radio/TV technician for help.