



DVD



Mechless

# VX3528

6.2" Double DIN Multimedia Receiver

AM-FM / DVD / Pandora / Bluetooth / iPhone® - iPod®  
USB / AV In / Rear Camera In

## INSTALLATION & OWNER'S MANUAL

**JENSEN®**

### Preparation

Please read entire manual before installation.

#### Before You Start

- Disconnect negative battery terminal. Consult a qualified technician for instructions.
- Avoid installing the unit where it would be subject to high temperatures, such as from direct sunlight, or where it would be subject to dust, dirt or excessive vibration.

#### Getting Started

- Remove trim ring from unit.
- Remove 2 transit screws located on top of the unit.
- Insert the supplied keys into the slots as shown, and slide the unit out of the mounting sleeve.
- Install mounting sleeve into opening, bending tabs to secure.
- Connect wiring harness and antenna. Consult a qualified technician if you are unsure.
- Certain vehicles may require an installation kit and/or wiring harness adapter (sold separately).
- Test for correct operation and slide into mounting sleeve to secure.
- Snap trim ring into place.

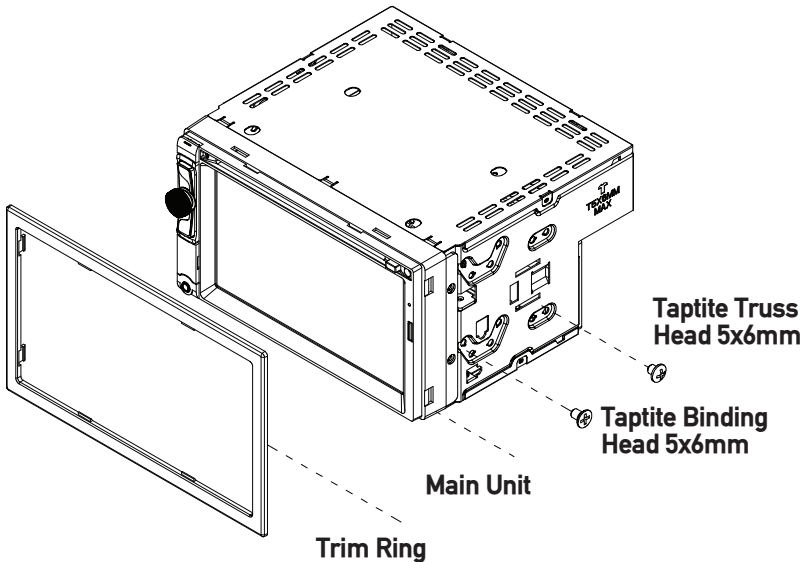

TYPICAL FRONT-LOAD DIN MOUNTING METHOD

### Wiring Diagram

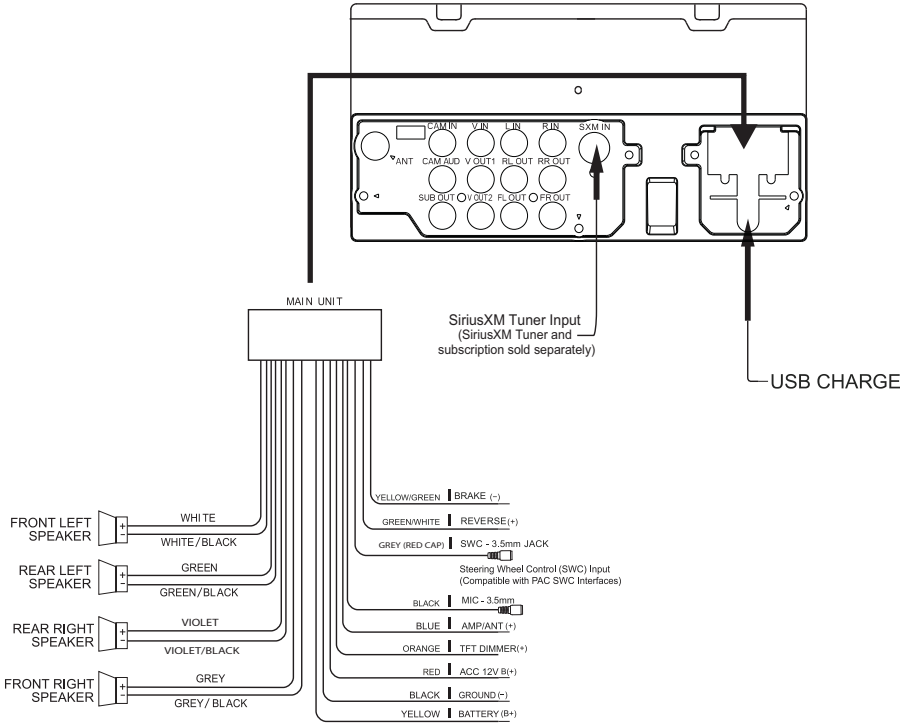

**Note:**

When replacing a fuse, make sure to use the correct type and amperage. Using an incorrect fuse could cause damage. The unit uses (1) 10 amp blade-type fuse located on the back of the unit.

**Wiring Notes:**

**Rear camera input**

A rear view camera (not included) can be used with the Camera input.

**SiriusXM**

For more information on how to install the SiriusXM Connect Vehicle tuner, consult the installation guide included with the tuner (SiriusXM connect tuner and subscription sold separately).

### Control Locations







- ① Eject / Voice
- ② EQ
- ③ Source
- ④ Power / Volume / Mute
- ⑤ Additional Inputs (USB, AV)
- ⑥ IR Remote Sensor
- ⑦ Reset Button
- ⑧ Disc Slot

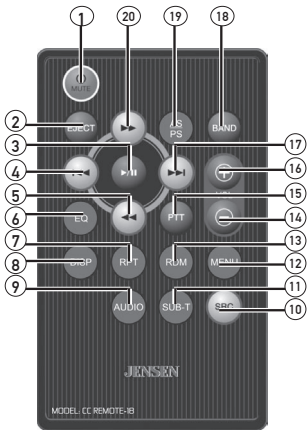

- ① Power / Mute
- ② Eject
- ③ Play / Pause
- ④ Tune / Track Down
- ⑤ Previous
- ⑥ EQ
- ⑦ Repeat
- ⑧ Display
- ⑨ Audio
- ⑩ Source
- ⑪ Subtitle
- ⑫ Menu
- ⑬ Random
- ⑭ Volume Down
- ⑮ PTT
- ⑯ Volume Up
- ⑰ Tune / Track Up
- ⑱ Band
- ⑲ AS/PS
- ⑳ Next



## General Operation

<b>Power On/Off</b>	Press  or any other button (except Eject) to turn the unit on. Press and hold  to turn the unit off.
<b>Source</b>	Press <b>SRC</b> to access available input modes: Radio, Disc, Pandora, USB, Bluetooth Phone, Bluetooth Audio, SiriusXM, AV In 1, AV In 2, Camera and Settings. Disc or USB device must be connected/inserted to appear in the mode selection string.
<b>Volume</b>	Rotate the <b>volume knob</b> to increase or decrease the volume level.
<b>Mute</b>	Momentarily press  to silence the audio. Momentarily press  again to return to the previously selected volume. Rotating the <b>volume knob</b> while the muted will also cancel the mute function.
<b>Auxiliary Input</b>	Connect external audio devices to the 3.5mm auxiliary input on the front panel.
<b>USB Port</b>	Connect a USB device to the USB port on the front panel to play MP3 files.
<b>Main Menu</b>	From any operational mode, press the arrow icon in the top left corner to access the Main Menu screen. Use the right and left arrows in the bottom corners to navigate between the two Main Menu screens, and touch any icon to directly access the corresponding mode.

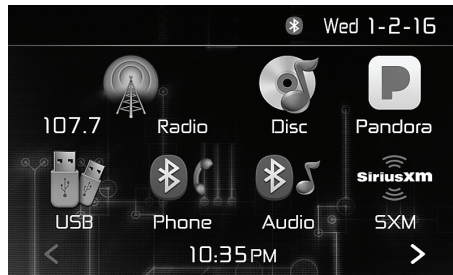

# General Operation

**Setup Menu** From the Main Menu screen, press **Settings** in the bottom right corner to access the Setup Menu and select from the following categories: General, Time, Display, Panel, Disc, Radio, General, Illumination, Wallpaper and Version.

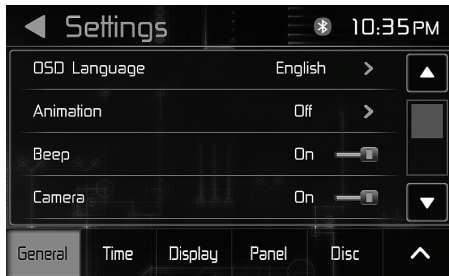

After accessing the desired category, press the up/down arrows to navigate all the category options and use the touch screen to adjust each option.

### General:

- **OSD Language** - Select English as the language for the on-screen display.
- **SRC** - Select to choose the desired source for each option: SRC1, SRC2, SRC3 and SRC4.
- **Beep** - Select to turn the audible beep On or Off.
- **Camera** - Select to turn the camera On or Off.
- **Parking Guideline** - Select to turn parking guidelines On or Off.

### Time:

- Set the year, month and day, select between a 12-hour and 24-hour clock display and set the hour and minute for the clock display.

### Display:

- Adjust the following display options (-20 to 20): Brightness, Contrast, Hue, Saturation and Sharpness.

### Panel:

- **Dimmer** - Turn the dimmer On or Off.
- **Dimmer Level** - Select between Level 1, Level 2 or Level 3.
- **Panel Adjust** - Press and follow the prompts to calibrate the touch screen.

### Disc:

- **Audio Language** - Select desired language for audio.
- **Subtitle Language** - Select desired language for subtitles.
- **Menu Language** - Select desired language for the menus.
- **Aspect Ratio** - Select from the following ratios: 4:3PS, 4:3LB and 16:9.
- **Change Password** - Select and follow the prompts to change password.
- **Rating** - Select specific parental control rating, if desired.

## General Operation

**Setup Menu**

**Radio:**

- **Dual** - Select between Stereo and Mono operation.
- **Local** - Select between Local and Distance tuning
- **Area** - Select between Europe, USA, American1 American 2 and OIRT.
- **RDS** - Select On or Off.
- **RDS Region** - Select On or Off.
- **PI** - Select Sound or Mute.
- **TA** - Select to turn traffic announcements On or Off.
- **AF** - Select to turn alternative frequencies On or Off.
- **Radio Text** - Select to turn radio text On or Off.
- **Clock Sync** - Select to turn clock sync On or Off.
- **Traffic Volume** - Select to turn traffic volume On or Off.

**Bluetooth:**

- **Bluetooth** - Turn Bluetooth On or Off.
- **Auto Connect** - Select On to program the unit to automatically connect to available Bluetooth devices.
- **Auto Answer** - Select On to program the unit to automatically answer incoming calls using Bluetooth.
- **Auto Load Record** - Turn auto load record On or Off.
- **Auto Load Phonebook** - Select On to automatically load the phonebook from your phone.
- **Change PIN** - Select to change the PIN.

**SXM:**

- **Change Password** - Press and follow the prompts to change the unit's password.

**Illumination:**

- Press to adjust color settings for illumination.

**Wallpaper:**

- Press to select a wallpaper for the on-screen display.

**Version:**

- Press to display version numbers or to restore the unit to factory default settings.

### Radio Operation



**Radio Operation** Select the Radio icon from the Main Menu screen.

**Main Menu** (1) Press to return to Main Menu screen.

**Current Mode Indicator** (2) Displays current mode of operation.

**Current Frequency** (3) Displays current frequency.

**Source** (4) Press to view and select available sources.

**Band** (5) Press to select between 3 FM and 2 AM bands.

**Seek Tune Down** (6) Press to tune down by seeking the next strong station.

**Auto Store** (7) Press to automatically store the six strongest stations in the current band as presets.

**Manually Tune Down** (8) Press momentarily to tune the unit down one step at a time.

**Manually Tune Up** (9) Press momentarily to tune the unit up one step at a time.

**Seek Tune Up** (10) Press to tune up by seeking the next strong station.

**Additional Options** (11) Press to view additional options.

**Preset Stations** (12) To store a preset station, tune unit to desired station, then press and hold the desired preset button to store the current station in that preset spot. Up to 18 FM and 12 AM stations can be stored in memory. Momentarily press any preset station to play it instantly.



### Radio Operation



- Local / Distance** ⑬ Press to select between Local or Distance tuning.
- Mono / Stereo** ⑭ Press to select Stereo or Mono operation.
- Program Type** ⑮ Press to view and select a station category, and the unit will automatically seek stations with that type of programming.
- Direct Entry** ⑯ Press to directly enter the desired station number and begin playback of that station.
- EQ** ⑰ Press to enter the Audio Settings menu and adjust the following audio options:
  - **EQ** - Use the touch screen to adjust equalization curves to suit individual listening preferences. The following equalizer frequencies are available for adjustment: 80Hz, 160Hz, 320Hz, 600Hz, 1kHz, 3kHz, 8kHz and 16kHz. An adjustment range of +16dB to -16dB is available for each frequency band.
  - **Fader-Balance** - Use the touch screen to adjust the balance of the audio output levels throughout the vehicle. The fader adjusts levels front to back, and the balance adjust from left to right.
  - **Audio** - Use the touch screen to adjust the following options: Subwoofer (On or Off), Subwoofer Frequency (80Hz, 120Hz or 160Hz), Loudness (On or Off) and Loudness Center Frequency (400Hz, 800Hz or 2400Hz).
  - **SRC Level** - Adjust audio levels for each audio source (Disc, USB, etc.)
- Traffic Announcements** ⑱ Press to turn the Traffic Announcements feature On or Off.
- Alternative Frequencies** ⑲ Press to turn the Alternative Frequencies feature On or Off.

### CD Operation

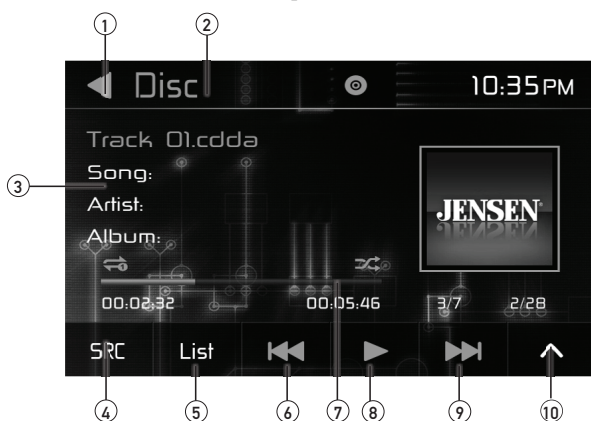

#### CD Operation

Insert a disc (label facing up), and playback will begin automatically. To switch to CD mode from another mode of operation when a disc is already inserted, select the Disc icon from the Main Menu screen.

#### Main Menu ①

Press to return to Main Menu screen.

#### Current Mode Indicator ②

Displays current mode of operation.

#### File Information ③

Displays information about the current track, including track number, song title, artist name and album name.

#### Source ④

Press to view and select available sources.

#### List ⑤

Press to view a list of files on the disc. Use the up/down arrows to scroll through the list, then press the file name twice to begin playback of that track. When searching all tracks, Order will appear on the right side of the screen. Press this button to switch to viewing tracks by Folder, then press the desired folder name twice to view only the tracks contained in that folder.

When viewing file lists, the unit will show music lists by default. To view lists of photo or video files, press the corresponding icon on the bottom of the screen.

#### Previous Track ⑥

Press to return to the previous track. Press and hold to skip to the beginning of the current track.

#### Elapsed Time ⑦

Displays the elapsed time and time remaining for the current track.

#### Play/Pause ⑧

Press to stop or restart playback.

#### Next Track ⑨

Press to advance to the next track.

#### Additional Options ⑩

Press to display additional options.

## CD Operation



**Repeat** ⑪ Press to select one of the following option for Repeat play: Repeat 1, Repeat Folder, Repeat All or Repeat Off.

**Random** ⑫ Press to turn Random playback On or Off.

**Direct Entry** ⑬ Press to directly enter a folder (optional) and track number to begin playback of specific track.

**EQ** ⑭ Press to enter the Audio Settings menu and adjust the following audio options:

- **EQ** - Use the touch screen to adjust equalization curves to suit individual listening preferences. The following equalizer frequencies are available for adjustment: 80Hz, 160Hz, 320Hz, 600Hz, 1kHz, 3kHz, 8kHz and 16kHz. An adjustment range of +16dB to -16dB is available for each frequency band.
- **Fader-Balance** - Use the touch screen to adjust the balance of the audio output levels throughout the vehicle. The fader adjusts levels front to back, and the balance adjust from left to right.
- **Audio** - Use the touch screen to adjust the following options: Subwoofer (On or Off), Subwoofer Frequency (80Hz, 120Hz or 160Hz), Loudness (On or Off) and Loudness Center Frequency (400Hz, 800Hz or 2400Hz).
- **SRC Level** - Adjust audio levels for each audio source (Disc, USB, etc.)

**Traffic Announcements** ⑮ Press to turn the Traffic Announcements feature On or Off.

### USB Operation



#### USB Operation

Connect a USB device, and playback will begin automatically. To switch to USB mode from another mode of operation when a device is already inserted, select the Disc icon from the Main Menu screen.

#### Main Menu ①

Press to return to Main Menu screen.

#### Current Mode Indicator ②

Displays current mode of operation.

#### File Information ③

Displays information about the current file, including file name, song title, artist name and album name.

#### Source ④

Press to view and select available sources.

#### List ⑤

Press to view a list of files on the device. Use the up/down arrows to scroll through the list, then press the file name twice to begin playback of that file. When searching all files, Order will appear on the right side of the screen. Press this button to switch to viewing files by Folder, then press the desired folder name twice to view only the files contained in that folder.

#### Previous File ⑥

Press to return to the previous file. Press and hold to skip to the beginning of the current file.

#### Elapsed Time ⑦

Displays the elapsed time and time remaining for the current file.

#### Play/Pause ⑧

Press to stop or restart playback.

#### Next File ⑨

Press to advance to the next file.

#### Additional Options ⑩

Press to display additional options.

## USB Operation



**Repeat** ⑪ Press to select one of the following option for Repeat play: Repeat 1, Repeat Folder, Repeat All or Repeat Off.

**Random** ⑫ Press to enable or disable random playback.

**Direct Entry** ⑬ Press to directly enter a folder (optional) and file number to begin playback of specific file.

**EQ** ⑭ Press to enter the Audio Settings menu and adjust the following audio options:

- **EQ** - Use the touch screen to adjust equalization curves to suit individual listening preferences. The following equalizer frequencies are available for adjustment: 80Hz, 160Hz, 320Hz, 600Hz, 1kHz, 3kHz, 8kHz and 16kHz. An adjustment range of +16dB to -16dB is available for each frequency band.
- **Fader-Balance** - Use the touch screen to adjust the balance of the audio output levels throughout the vehicle. The fader adjusts levels front to back, and the balance adjust from left to right.
- **Audio** - Use the touch screen to adjust the following options: Subwoofer (On or Off), Subwoofer Frequency (80Hz, 120Hz or 160Hz), Loudness (On or Off) and Loudness Center Frequency (400Hz, 800Hz or 2400Hz).
- **SRC Level** - Adjust audio levels for each audio source (Disc, USB, etc.)

**Traffic Announcements** ⑮ Press to turn the Traffic Announcements feature On or Off.

### iPod Operation



#### iPod Operation

The unit will automatically switch to iPod® or iPhone® mode when an iPod® or iPhone® is plugged into the front panel USB connector. iPod® mode can be accessed from the Main Menu by touching the iPod® icon (only available when an iPod® or iPhone® is connected).

**Note:** For audio playback, the iPod® / iPhone® must be connected using the iPod® / iPhone® adapter cable that came with the iPod / iPhone device (also available separately). Be sure your device has the latest Apple firmware installed to avoid connectivity issues.

#### Main Menu ①

Press to return to Main Menu screen.

#### Current Mode Indicator ②

Displays current mode of operation.

#### File Information ③

Displays information about the current file, including file name, song title, artist name and album name.

#### Source ④

Press to view and select available sources.

#### List ⑤

Press to view a list of files on the device. Use the up/down arrows to scroll through the list of categories to view files by Playlist, Artist, Album, Genres, Song, Composers or Audiobooks. Press the desired category name twice to view and select from all files in that category.

#### Previous File ⑥

Press to return to the previous file. Press and hold to skip to the beginning of the current file.

#### Elapsed Time ⑦

Displays the elapsed time and time remaining for the current file.

#### Play/Pause ⑧

Press to stop or restart playback.

#### Next File ⑨

Press to advance to the next file.

#### Additional Options ⑩

Press to display additional options.

## iPod Operation



**Repeat** ⑪ Press to select one of the following option for Repeat play: Repeat 1, Repeat Folder, Repeat All or Repeat Off.

**Random** ⑫ Press to enable or disable random playback.

**Direct Entry** ⑬ Press to directly enter a folder (optional) and track number to begin playback of specific track.

**EQ** ⑭ Press to enter the Audio Settings menu and adjust the following audio options:

- **EQ** - Use the touch screen to adjust equalization curves to suit individual listening preferences. The following equalizer frequencies are available for adjustment: 80Hz, 160Hz, 320Hz, 600Hz, 1kHz, 3kHz, 8kHz and 16kHz. An adjustment range of +16dB to -16dB is available for each frequency band.
- **Fader-Balance** - Use the touch screen to adjust the balance of the audio output levels throughout the vehicle. The fader adjusts levels front to back, and the balance adjust from left to right.
- **Audio** - Use the touch screen to adjust the following options: Subwoofer (On or Off), Subwoofer Frequency (80Hz, 120Hz or 160Hz), Loudness (On or Off) and Loudness Center Frequency (400Hz, 800Hz or 2400Hz).
- **SRC Level** - Adjust audio levels for each audio source (Disc, USB, etc.)

**Traffic Announcements** ⑮ Press to turn the Traffic Announcements feature On or Off.

### Pandora Operation

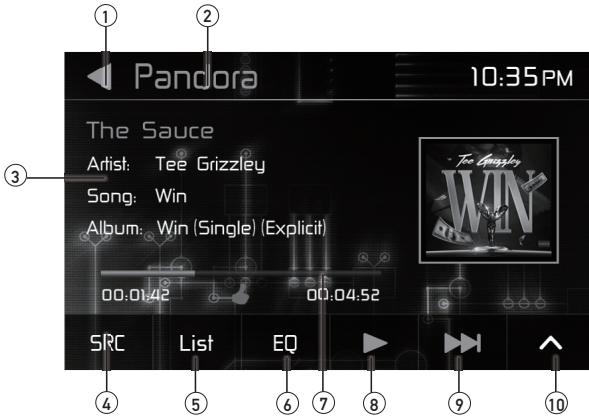

#### Pandora Operation

Pandora Radio is available (in the United States, Australia and New Zealand) on your iPhone® - iPod® touch via USB cable or an Android™ device via Bluetooth. Data usage may occur. **Note:** The Pandora Radio app must be installed on your device.

#### Main Menu ①

Press to return to Main Menu screen.

#### Current Mode Indicator ②

Displays current mode of operation.

#### Information Display ③

Displays information about the current song, including Station Name, Song Title, Artist Name and Album Name.

#### Source ④

Press to view and select available sources.

#### Station List ⑤

Press to search for music by stations you created. Use the up/down arrows to navigate the list, then press a station name to access that station. Press Recent to see only recent stations.

#### EQ ⑥

Press to enter the Audio Settings menu and adjust the following audio options:

- EQ - Use the touch screen to adjust equalization curves to suit individual listening preferences.
- Fader-Balance - Use the touch screen to adjust the balance of the audio output levels throughout the vehicle.
- Audio - Use the touch screen to adjust the following options: Subwoofer (On or Off), Subwoofer Frequency (80Hz, 120Hz or 160Hz), Loudness (On or Off)
- SRC Level - Adjust audio for each audio source (Disc, USB, etc.)

#### Elapsed Time ⑦

Displays the elapsed time and time remaining for the current file.

#### Play / Pause ⑧

Press to pause or resume playback.

#### Skip ⑨

Press to skip to the next song (subject to Pandora's skip limit).

#### Additional Options ⑩

Press to view additional options.



## Pandora Operation



- Bookmark Track ⑪** Press to tell Pandora you like the track currently playing, and Pandora will play more tracks like it.
- Bookmark Artist ⑫** Press thumbs down to tell Pandora you do not like the track. The track will be skipped, if possible, and your feedback will be recorded.
- Bookmark Track ⑬** Press to bookmark a track.
- Bookmark Artist ⑭** Press to bookmark an artist.
- Bookmark Artist ⑮** Press to turn the Traffic Announcements feature On or Off.

### Bluetooth Operation



**Preparation**

Before you can use a Bluetooth device, it must be paired and connected. Make sure that Bluetooth is activated on your device before you begin the pairing process.

**Pairing a New Device**

The unit broadcasts the pairing signal constantly when no devices are currently connected. Complete the pairing sequence from your Bluetooth device. Refer to the owner's manual for your device for more details. **The device name is "JENSEN". The Bluetooth passcode "5309".** The unit can be in any mode of operation when pairing is performed.

**Connecting a Paired Device**

Most Bluetooth devices support the auto-connect feature and will connect automatically if the device is in range when the unit is powered-on. If your device was previously paired but does not connect, enter the Bluetooth setup menu and ensure that Auto Connect is On.

**Bluetooth Phone**

To access the phone, select Bluetooth Phone from the Main Menu.

**Main Menu** ①

Press to return to the Main Menu screen.

**Current Mode Indicator** ②

Displays current mode of operation.

**Phone Keypad** ③

Use the phone keypad to dial the desired phone number. Alternately, numbers can be dialed directly from the phone.

**Keypad** ④

Press to display keypad and dial a number.



**Incoming Call** ⑤

Press to display a list of received calls. Use the up/down arrows to scroll through the list, and press desired number to connect a call.

**Outgoing Call** ⑥

Press to display a list of outgoing calls. Use the up/down arrows to scroll through the list, and press desired number to connect a call.

**Connect or End Call** ⑦

Press  after dialing a number to connect a call. Press  during a phone call to end the call.

## Bluetooth Operation



- Missed Call** ⑧ Press to display a list of missed calls. Use the up/down arrows to scroll through the list, and press desired number to connect a call.
- Redial** ⑨ Press to redial the most recently-dialed number.
- Backspace** ⑩ When dialing the number, press to backspace when needed.
- Contacts** ⑪ Press to display a list of stored contacts. Use the up/down arrows to scroll through the list, and press desired number to connect a call. The keypad on the left side of the screen allows direct entry of a contact name for quicker access.
- Voice Access** ⑫ Press to access Siri or Google Voice through the head unit when connected via Bluetooth. Your phone must support Siri or Google Voice in order for this feature to be supported on the head unit.
- Note:** Samsung "S" Voice and other third-party apps may not be supported.
- Device** ⑬ Press to display a list of available devices. Use the up/down arrows to scroll through the list, and press desired number to connect to that device. Press the red disconnect button to the right of a device name to disconnect and/or delete that device.
- Bluetooth Music** To use your Bluetooth connection to play music from your device, press #5 or select Bluetooth Music from the Main Menu.
- Redial** ⑭ Press to go back to the previous file or track.
- Backspace** ⑮ Press to pause or resume playback.
- Contacts** ⑯ Press to advance to the next file or track.

### SiriusXM® Satellite Radio Operation

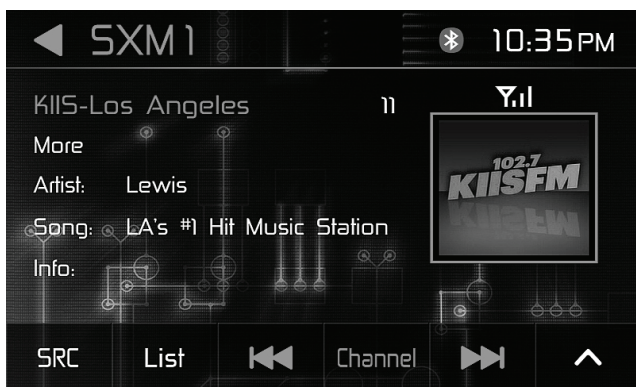

#### SiriusXM® Radio

Only SiriusXM® Satellite Radio brings you more of what you love to listen to, all in one place. Get over 140 channels, including commercial-free music plus the best sports, news, talk, comedy and entertainment. Welcome to the world of satellite radio. A SiriusXM Vehicle Tuner and Subscription are required. For more information, visit [www.siriusxm.com](http://www.siriusxm.com).

#### Activating SiriusXM® Radio

After installing your SiriusXM Connect Vehicle Tuner and antenna, power on your radio and select SiriusXM mode. You should be able to hear the SiriusXM preview channel on Channel 1. After you can hear the Preview channel, tune to Channel 0 to find the Radio ID of your tuner. The Radio ID is located on the bottom of the SiriusXM Connect Vehicle Tuner and its packaging.

**Note:** SiriusXM Radio ID does not include the letters I, O, S or F.

In the USA, activate online or by calling SiriusXM Listener care:

- Visit [www.siriusxm.com/activatenow](http://www.siriusxm.com/activatenow)
- Call SiriusXM Listener Care at 1-866-635-2349

For Canadian Subscriptions, please contact:

- Visit [www.siriusxm.ca/activatexm](http://www.siriusxm.ca/activatexm)
- Call XM customer Care at 1-877-438-9677

Activation typically takes 10-15 minutes, but may take up to one hour. It is recommended to leave your vehicle on until the "Subscription Updated" message appears. Your radio will need to be powered on and receiving the SiriusXM signal to receive the activation message.

Once activated, you can tune to channels in your subscription plan.

#### Accessing SiriusXM® Radio

From the Main Menu, touch the SiriusXM icon to access SiriusXM mode and begin operation.

## SiriusXM® Satellite Radio Operation

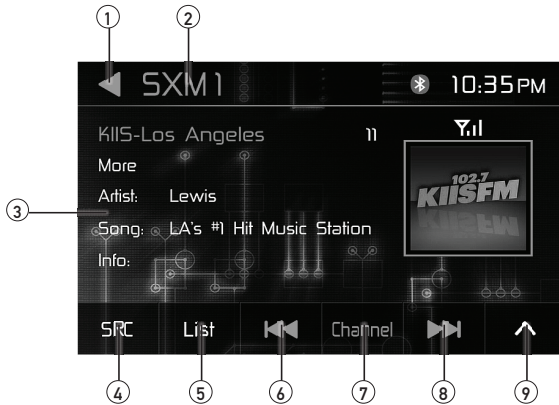

**Main Menu** ① Press to return to the Main Menu screen.

**Current Mode Indicator** ② Displays current mode of operation.

**File Information** ③ Displays information about the current song, including Station Name, Song Title, Artist Name and Album Name.

**Information Display** ④ Displays program information such as channel name, category, song title, artist name and any additional information available.

**List** ⑤ Press to enter search mode, then use the up/down arrows to navigate the lists. Channel list is displayed by default. Press the Channel button to view lists by song, artist, additional information or category. Press Preset to view only preset channels in the list, or press Category to view a list of categories. Once the desired option is selected, press twice to begin playback.



**Category & Channel Search**

**Previous** ⑥ Press to tune down to the previous channel or category.

**Channel/Category** ⑦ Press to toggle between channel and category tuning.

**Next** ⑧ Press to tune up to the next channel or category.

**Additional Options** ⑨ Press to view additional options.

### SiriusXM® Satellite Radio Operation

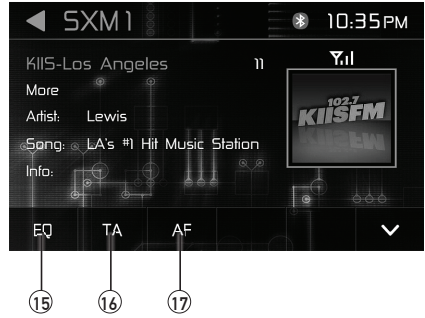

**Band** ⑩ Touch to select a band of preset channels. Three bands are available: SXM1, SXM2, and SXM3. Each band can store up to six preset channels. (Preset channels are accessed from the List icon.)

**Memory** ⑪ Press to view a list of preset channels for each channel, song, artist, info or category. Press any preset number twice to save the current station in that preset spot.

**Scan** ⑫ Press to scan all channels in the current band and listen five seconds at each channel. Press again to stop scan and resume playback.

**Lock** ⑬ Touch to display the SXM Lock Screen to set controls, if desired.

**Direct Entry** ⑭ Press to directly enter channel number and begin channel playback.

**EQ** ⑮ Press to enter the Audio Settings menu and adjust the following audio options:

- **EQ** - Use the touch screen to adjust equalization curves to suit individual listening preferences. The following equalizer frequencies are available for adjustment: 80Hz, 160Hz, 320Hz, 600Hz, 1kHz, 3kHz, 8kHz and 16kHz. An adjustment range of +16dB to -16dB is available for each frequency band.
- **Fader-Balance** - Use the touch screen to adjust the balance of the audio output levels throughout the vehicle. The fader adjusts levels front to back, and the balance adjust from left to right.
- **Audio** - Use the touch screen to adjust the following options: Subwoofer (On or Off), Subwoofer Frequency (80Hz, 120Hz or 160Hz), Loudness (On or Off) and Loudness Center Frequency (400Hz, 800Hz or 2400Hz).
- **SRC Level** - Adjust audio levels for each audio source (Disc, USB, etc.)

**Traffic Announcements** ⑯ Press to turn the Traffic Announcements feature On or Off.

**Alternative Frequencies** ⑰ Press to turn the Alternative Frequencies feature On or Off.

## Unlocking a Channel

To unlock an individual channel

1. On the SiriusXM menu page, touch the lock icon. The Enter password Screen appears.
2. Enter your 4-digit password. The following screen appears:



### Unlock Screen

3. Touch a lock (🔒) icon until icon disappears. Channel is unlocked.
4. Touch Unlock All icon to unlock all channels.

Change Lock Password

The Change Lock Password option allows you to change the password from the default or current custom password to another password.

NOTE: The default password is 0, 0, 0, 0.

To Change password:

1. Enter into Settings menu. Go to SXM to change password.



Settings to SXM Screen



Change Password Screen

2. Enter your 4-digit password and press the OK icon.
3. Enter the new 4-digit password and press the OK icon. The new password is set.

### Front 3.5mm Aux Input & Rear RCA A/V Input

<b>Auxiliary Input</b>	<p>Connect an optional audio source into the 3.5mm (front panel) input.</p> <p>Select auxiliary input from the Main Menu to listen to audio.</p> <p>Adjust volume on the external audio source as needed (if connected to the headphone output of the device).</p>
<b>Using AV Input</b>	<p>Connect an optional audio/video source to the rear auxiliary input (Red/White/Yellow RCA connectors). Refer to page 6 for details.</p> <p>Select AV Input from the Main Menu to listen to audio.</p> <p>Engage parking brake to watch video.</p>

### Rear Camera Operation - (Optional)

<b>Using Rear Camera</b>	<p>Connect an optional rear camera to the Camera Input (Black RCA connector). Refer to the wiring diagram for details.</p> <p>Manual selection - Touch CAMERA icon from the Main Menu or from any operational mode (when enabled) to select camera mode. Touch the top left area on the screen to exit camera mode.</p> <p><b>Note:</b> The manual mode is for dedicated cameras that are ALWAYS on while driving, it is not meant for cameras that are connected to the vehicle's reverse light.</p>
<b>Auto Selection</b>	<p>The unit will automatically select camera mode when connected to the reverse lamp circuitry.</p> <p><b>Note:</b> The external video output is not active when using the rear camera input.</p>



## SWC Input Operation

The built-in SWC Interface is compatible with PAC steering wheel control modules. The PAC SWI-RC is recommended. A third-party adapter must be used in order for the radio to be compatible with any steering wheel controls. The following controls are available for most vehicles.

1. Volume Up (+)	4. Preset (+)	7. Seek/Track Up (+)	10. BT Talk
2. Volume Down (-)	5. Preset (-)	8. Seek/Track Down (-)	11. BT End
3. Mute	6. Mode	9. Band	

**Note:** Not all OE steering wheel functions may be supported by the radio.

## PAC SWI-RC Installation Hints

1. Set "Radio Select Switch". Set the SWI-RC to position 7 - "Pioneer/Other/Sony".
2. To program, use the Pioneer/Sony/Other radio function mapping order for Dual units.
3. When programming the SWI-RC, if a function is not supported (or not desired), then the function **MUST** be skipped as per the PAC SWI-RC instructions.
4. The SWC function **MUST** be programmed in the correct order per the PAC SWI-RC radio function mapping order instructions.

Function Order	Function Mapping	SWI-RC (3.3VDC Reference)	
		Center Pin (Ring) Voltage (Function Select)	Tip Pin Voltage
1	Volume +	H 5.0v	2.07
2	Volume -	H 5.0v	2.32
3	Mute	H 5.0v	1.01
4	Preset +	L 0.0V	1.54
5	Preset -	L 0.0V	1.81
6	Source	H 5.0v	0.60
7	Seek + / Track +	H 5.0v	1.54
8	Seek - / Track -	H 5.0v	1.81
9	Band	H 5.0v	2.73
10	BT Talk	L 0.0V	0.60
11	BT End	L 0.0V	1.01

## Media Compatibility

<p><b>Media Compatibility</b></p>	<p>The following types of discs/files are compatible:</p> <ul style="list-style-type: none"> <li>• CD-DA, CD-ROM (ISO), CD-R, CD-RW</li> <li>• DVD Video, DVD+R/RW, DVD-R/RW</li> </ul> <p>The following types of discs/files are not compatible:</p> <ul style="list-style-type: none"> <li>• WMA files that are protected by DRM (Digital Rights Management)</li> <li>• WMA lossless format</li> <li>• Discs recorded with Track At Once or packet writing</li> <li>• MP3 PRO format, MP3 playlists</li> <li>• RMP format</li> <li>• WAV format</li> <li>• WMV format</li> <li>• AAC, protected AAC, M4V, M4A format</li> </ul> <p>Some recordable DVD's and CD's may be incompatible with this unit, depending on media type and recording method.</p>
<p><b>Playback Order</b></p>	<p>MP3 playback sequence begins in the root folder of the disc, USB flash drive or SD card. Any empty folders or folders that do not include MP3 files are skipped.</p>
<p><b>Compatible Recording Formats</b></p>	<p>ISO9660 standards:</p> <ul style="list-style-type: none"> <li>• Maximum nested folder depth is 8 (including the root folder).</li> <li>• Valid characters for folder/file names are letters A-Z (all caps), numbers 0-9, and "_" (underscore). Some characters may not be displayed correctly, depending on the character type.</li> <li>• This device can play back discs in Joliet and other standards that conform to ISO9660. MP3 written in the formats other than the above may not play and/or their file names or folder names may not be displayed properly.</li> </ul>
<p><b>Notes</b></p>	<p>Some files may not play or be displayed correctly, depending on sampling rates and bit rates.</p> <p>For best results, use the following settings when ripping MP3 files:          128kbps or higher constant bit rate          44.1kHz or higher sampling frequency</p>

** WARNING **

Upon installation of this Monitor/DVD player ("unit") into a vehicle, the driver of the vehicle must not operate this unit by watching videos or playing video games while driving. Failure to follow this instruction could lead to driver distraction which could result in serious injury or death to the vehicle's occupants or persons outside the vehicle and/or property damage.

Several states prohibit the installation of monitors/DVD players if the screen is visible from the driver's seat. If you reside in a jurisdiction which has enacted such a law, this unit must not be installed so that the screen is visible from the driver's seat. When installing this unit in the front console/dashboard, the unit must be positioned so that it is facing the front passenger seat only. Failure to follow this instruction could lead to driver distraction which could result in serious injury or death to the vehicle's occupants or persons outside the vehicle and/or property damage.

This unit is designed so that it may be operated only when the vehicle is in "Park" and the parking brake is fully engaged. To this end, this unit includes a parking brake lock-out feature which prohibits the unit from operating if the vehicle is not in "Park" and/or the parking brake is not fully engaged. When installing this unit, the installer must connect the parking brake detect wire to the parking brake mechanism in order to make the parking brake lock-out feature operable. **DO NOT** simply ground the parking brake detect wire to a metal portion of the vehicle. Failure to properly install the parking brake lock-out feature could lead to driver distraction which could result in serious injury or death to the driver's occupants or persons outside the vehicle and/or property damage.

Once the parking brake lock-out feature is installed, the owner/user must not attempt to disrupt/neutralize the parking brake lock-out feature by (a) partially engaging the parking brake and/or (b) purchasing/using any device or unit designed to send necessary brake signals to the unit. Failure to follow these instructions could lead to driver distraction which could result in serious injury or death to the driver's occupants or persons outside the vehicle and/or property damage.

When operating this unit, keep the unit's volume level low enough so that the vehicle's occupants can hear traffic-related sounds such as police and emergency vehicles. Failure to follow this instruction could lead to driver distraction which could result in serious injury or death to the vehicle's occupants or persons outside the vehicle and/or property damage.

## DVD Operation



- |                                 |  |
|---------------------------------|--|
| <b>DVD Operation</b>            | Insert a disc (label facing up), and playback will begin automatically. To switch to CD mode from another mode of operation when a disc is already inserted, select the Disc icon from the Main Menu screen. |
| <b>Main Menu</b> ①              | Press to return to Main Menu screen.   |
| <b>Current Mode Indicator</b> ② | Displays current mode of operation.  |
| <b>Source</b> ③                 | Press to view and select available sources.  |
| <b>Stop</b> ④                   | Press to stop DVD playback. When playback is resumed, it will begin at the beginning of the disc.  |
| <b>Tune / Track Down</b> ⑤      | Press to go back to the previous chapter. Press and hold to fast reverse DVD playback.   |
| <b>Play / Pause</b> ⑥           | Press to pause DVD playback. When playback is resumed, it will begin at the same point it was paused. Press again to resume DVD playback.  |
| <b>Tune / Track Up</b> ⑦        | Press to go forward to the next chapter. Press and hold to fast forward DVD playback.  |
| <b>Additional Options</b> ⑧     | Press view additional options for DVD playback.  |

### DVD Operation

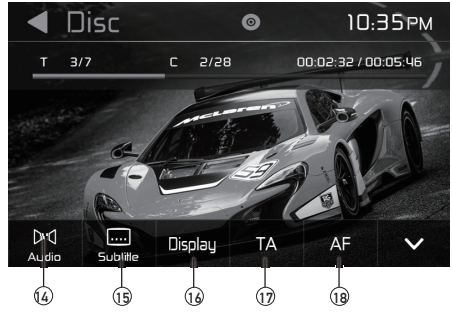

**Repeat** ⑨

Press to select one of the following option for Repeat play: Repeat 1, Repeat Folder, Repeat All or Repeat Off.

**Random** ⑩

Press to select one of the following option for Random play: On or Off.

**Direct Entry** ⑪

Press to access the keypa and directly enter title and chapter information to begin playback at a specific point.

**Main Menu** ⑫

Press to return to the Main Menu screen.

**Angle** ⑬

Press to rotate the on-screen display.

**Audio** ⑭

Press to adjust audio options.

**Subtitle** ⑮

Press to access the subtitles.

**Display** ⑯

Press to adjust the screen brightness, contrast, hue, saturation and sharpness.

**Traffic Announcements** ⑰

Press to turn the Traffic Announcements feature On or Off.

**Alternative Frequencies** ⑱

Press to turn the Alternative Frequencies feature On or Off.

## SiriusXM™ Radio Advisory Messages

SiriusXM Advisory Message	Recommendation
Check Antenna	<ol style="list-style-type: none"> <li>1. The radio has detected a fault with the SiriusXM antenna. The antenna cable may be either disconnected or damaged.</li> <li>2. Verify that the antenna cable is connected to the SiriusXM Connect Vehicle Tuner.</li> <li>3. Inspect the antenna cable for damage and kinks. Replace the antenna if the cable is damaged.</li> <li>4. SiriusXM products are available at your local car audio retailer or online at <a href="http://www.shop.siriusxm.com">www.shop.siriusxm.com</a>.</li> </ol>
Check Tuner	<ol style="list-style-type: none"> <li>1. The radio is having difficulty communicating with the SiriusXM Connect Vehicle Tuner. The tuner may be disconnected or damaged.</li> <li>2. Verify that the SiriusXM Connect Vehicle Tuner cable is securely connected to the radio</li> </ol>
No Signal	<ol style="list-style-type: none"> <li>1. The SiriusXM Connect Vehicle Tuner is having difficulty receiving the SiriusXM satellite signal.</li> <li>2. Verify that your vehicle is outdoors with a clear view of the sky.</li> <li>3. Verify that the SiriusXM magnetic mount antenna is mounted on a metal surface on the outside of the vehicle.</li> <li>4. Move the SiriusXM antenna away from any obstructions.</li> <li>5. Inspect the antenna cable for damages and kinks.</li> <li>6. Consult the SiriusXM Connect Vehicle tuner installation manual for more information on antenna installation. Replace the antenna if the cable is damaged. SiriusXM products are available at your local car audio retailer or online at <a href="http://www.shop.siriusxm.com">www.shop.siriusxm.com</a>.</li> </ol>
Subscription Updated	<p>This channel is not included in your SiriusXM® subscription plan. In the USA, visit <a href="http://www.siriusxm.com">www.siriusxm.com</a> or call 1-866-635-2349 if you have questions about your subscription. In Canada, visit <a href="http://www.siriusxm.ca">www.siriusxm.ca</a> or call 1-877-438-9677 if you have questions about your subscription.</p>
Channel Unavailable	<p>The channel that you have requested is not a valid SiriusXM channel or the channel that you were listening to is no longer available. You may also see this message briefly when first connecting a new SiriusXM Connect Vehicle tuner. Visit <a href="http://www.siriusxm.com">www.siriusxm.com</a> for more information about the SiriusXM channel lineup.</p>
Channel Unsubscribed	<p>The channel that you have requested is not included in your SiriusXM subscription package or is no longer included in your SiriusXM subscription package. In the USA, visit <a href="http://www.siriusxm.com">www.siriusxm.com</a> or call 1-866-635-2349 if you have questions about your subscription. In Canada, visit <a href="http://www.siriusxm.ca">www.siriusxm.ca</a> or call 1-877-438-9677 if you have questions about your subscription.</p>
Channel Locked	<p>The channel that you have requested is locked by the radio's Parental Control feature. Refer to the SiriusXM® Satellite Radio Operation section for more information on the Mature Channel Lock feature and how to access.</p>

## Troubleshooting

Problem	Cause	Action
<b>Unit will not turn on (no power)</b>	Yellow wire not connected or incorrect voltage Red wire not connected or incorrect voltage	Check connections for proper voltage (11~16VDC)
	Black wire not connected	Check connection to ground
	Fuse blown	Replace fuse
<b>Unit has power (but no sound)</b>	Speaker wires not connected	Check connections at speakers
	One or more speaker wires touching each other or touching chassis ground	Insulate all bare speaker wires from each other and chassis ground
<b>Unit blows fuses</b>	Yellow or red wire touching chassis ground	Check for pinched wire
	Speaker wires touching chassis ground	Check for pinched wire
	Incorrect fuse rating	Use fuse with correct rating
<b>Excessive skipping</b>	Unit is not mounted correctly or backstrap is not secure	Check mounting sleeve and backstrap support
	Physical defect in media (CD, CD-R or CD-RW)	Check media for scratches
<b>ERR FILE appears on display</b>	Disc read error	Press eject or <b>RESET</b>
	Focus error or disc is in upside down	Press eject or <b>RESET</b>
<b>NO FILE appears on display</b>	No playable MP3files found on the device	Check the device for valid MP3 files
<b>Unit will not accept a disc</b>	CD mechanism position out of alignment	Press <b>EJECT</b> to reset CD mechanism position
	CD transit screws still in place	Remove 2 transit screws located on top of the unit
<b>NO SUPPORT appears on display</b>	An invalid ID3 tag version is present	Version 1.0 to 2.0 ID3 tags are supported.

# Specifications

<b>CD Player</b>	<p>Frequency response: <b>20Hz-20kHz</b>                  Channel separation @ 1kHz: <b>&gt;60dB</b>                  D/A converter: <b>1 Bit</b></p>
<b>FM Tuner</b>	<p>Tuning range: <b>87.5MHz-107.9MHz</b>                  Usable sensitivity: <b>8.5dBf</b>                  50dB quieting sensitivity: <b>10dBf</b>                  Stereo separation @ 1kHz: <b>&gt;30dB</b>                  Frequency response: <b>30Hz-13kHz</b></p>
<b>AM Tuner</b>	<p>Tuning range: <b>530kHz-1710kHz</b>                  Usable sensitivity: <b>&lt;42dBu</b>                  Frequency response: <b>30Hz-2.2kHz</b></p>
<b>General</b>	<p>USB Charge: <b>1A</b>                  Speaker output impedance: <b>4~8 ohms</b>                  Line output voltage: <b>4 Volts RMS</b>                  Dimensions: <b>7" x 7" x 4" (178 x 178 x 100 mm)</b></p> <p>Design and specifications subject to change without notice.</p>



## CEA-2006 Power Standard Specifications (reference: 14.4VDC +/- 0.2V, 20Hz~20kHz)

Power Output: 16 Watts RMS x 4 channels at 4 ohms and  $\leq 1\%$  THD+N  
 Signal to Noise Ratio: 80dBA (reference: 1 watt into 4 ohms)



## Limited One Year Warranty

This warranty gives you specific legal rights. You may also have other rights which vary from state to state.

Dual Electronics Corp. warrants this product to the original purchaser to be free from defects in material and workmanship for a period of one year from the date of the original purchase.

Dual Electronics Corp. agrees, at our option, during the warranty period, to repair any defect in material or workmanship or to furnish an equal new, renewed or comparable product (whichever is deemed necessary) in exchange without charges, subject to verification of the defect or malfunction and proof of the date of purchase. Subsequent replacement products are warranted for the balance of the original warranty period.

**Who is covered?** This warranty is extended to the original retail purchaser for products purchased from an authorized Dual dealer and used in the U.S.A.

**What is covered?** This warranty covers all defects in material and workmanship in this product. The following are not covered: software, installation/removal costs, damage resulting from accident, misuse, abuse, neglect, product modification, improper installation, incorrect line voltage, unauthorized repair or failure to follow instructions supplied with the product, or damage occurring during return shipment of the product. Specific license conditions and copyright notices for the software can be found via [www.dualav.com](http://www.dualav.com).

### What to do?

1. Before you call for service, check the troubleshooting guide in your owner's manual. A slight adjustment of any custom controls may save you a service call.
2. If you require service during the warranty period, you must carefully pack the product (preferably in the original package) and ship it by prepaid transportation with a copy of the original receipt from the retailer to an authorized service center.
3. Please describe your problem in writing and include your name, a return UPS shipping address (P.O. Box not acceptable), and a daytime phone number with your shipment.
4. For more information and for the location of the nearest authorized service center please contact us by one of the following methods:

- Call us toll-free at 1-866-382-5476
- E-mail us at [cs@dualav.com](mailto:cs@dualav.com)

**Exclusion of Certain Damages:** This warranty is exclusive and in lieu of any and all other warranties, expressed or implied, including without limitation the implied warranties of merchantability and fitness for a particular purpose and any obligation, liability, right, claim or remedy in contract or tort, whether or not arising from the company's negligence, actual or imputed. No person or representative is authorized to assume for the company any other liability in connection with the sale of this product. In no event shall the company be liable for indirect, incidental or consequential damages.

## FCC Compliance

This device complies with Part 15 of the FCC Rules. Operation is subject to the following two conditions:

- (1) this device may not cause harmful interference, and
- (2) this device must accept any interference received, including interference that may cause undesired operation.

**Warning:** Changes or modifications to this unit not expressly approved by the party responsible for compliance could void the user's authority to operate the equipment.

**Note:** This equipment has been tested and found to comply with the limits for a Class B digital device, pursuant to Part 15 of the FCC Rules. These limits are designed to provide reasonable protection against harmful interference in a residential installation. This equipment generates, uses and can radiate radio frequency energy and, if not installed and used in accordance with the instructions, may cause harmful interference to radio communications. However, there is no guarantee that interference will not occur in a particular installation. If this equipment does cause harmful interference to radio or television reception, which can be determined by turning the equipment off and on, the user is encouraged to try to correct the interference by one or more of the following measures:

- Reorient or relocate the receiving antenna.
- Increase the separation between the equipment and receiver.
- Connect the equipment into an outlet on a circuit different from that to which the receiver is connected.
- Consult the dealer or an experienced radio/TV technician for help.

**JENSEN®**

**Dual Electronics Corp.  
Toll Free: 888-921-4088**

[www.jensenmobile.com](http://www.jensenmobile.com)  
©2018 Dual Electronics Corp. All rights reserved.

The Bluetooth® word mark and logos are owned by the Bluetooth SIG, Inc.  
and any use of such marks by Namsung is under license.

Other trademarks and trade names are those of their respective owners.

NSA1118-V01

---