



CAR7TC

Media Receiver with Android Auto™ and Apple CarPlay®
featuring a 7 " digital TFT Display

INSTALLATION & OWNER'S MANUAL



JENSEN®

Safety Notes

This is a safety feature to prevent driver distraction. In-dash video functions will only operate when vehicle is in Park and the parking brake is engaged. It is illegal in most jurisdictions for the driver to view video while the vehicle is in motion.

The SAFETY NOTICE is reminder to drive responsibly and safely while using your mobile phone device, or any apps that are compatible with this unit.

It is highly recommended that your Jensen unit is installed by a professional installer or an authorized dealer.

This product is only for use in vehicles with 12VDC negative ground only.

To prevent damage or injury:

- Make sure to ground the unit securely to the vehicle chassis ground.
- Do not remove the top or bottom covers of the unit.
- Do not install the unit in a spot exposed to direct sunlight, excessive heat or the possibility of water splashing.
- Do not subject the unit to excessive shock.
- When replacing a fuse, only use a new one with the correct rating. Using a fuse with the wrong rating may cause the unit to malfunction.
- To prevent short circuits when replacing a fuse, disconnect the wiring harness first.
- Use only the provided hardware and wire harness.
- If you experience problems during installation, consult your nearest Jensen dealer.
- If the unit malfunctions, reset the unit as described. If the problem still persists, consult your nearest Jensen dealer or call technical assistance @1-888-921-4088.
- To clean the monitor, wipe only with a dry silicone cloth or other soft cloth. Do not use a stiff cloth or solvents such as paint thinner and alcohol, as these can scratch the surface of the panel and/or remove the printing.
- When the temperature of the unit falls (as in winter), the liquid crystal inside the screen will become darker than usual. Normal brightness will return after the unit is in use for a while.
- When extending the ignition, battery or ground wiring, make sure to use automotive-grade wiring with an a minimum AWG 16 or more to prevent voltage drops.
- Do not touch the liquid crystal fluid if the LCD is damaged or broken. The liquid crystal fluid may be hazardous to your health or fatal. If the liquid crystal fluid from the LCD contacts your body or clothing, wash it off with soap immediately.

Copyright Notes

The Bluetooth® word mark and logos are owned by the Bluetooth SIG, Inc.

Use of the Apple CarPlay logo means that a vehicle user interface meets Apple performance standards. Apple is not responsible for the operation of this vehicle or its compliance with safety and regulatory standards. Please note that use of this product with iPhone, iPod or iPad may affect wireless performance. Apple CarPlay is a trademark of Apple Inc. "Made for iPod" and "Made for iPhone" mean that an electronic accessory has been designed to connect specifically to iPod or iPhone, respectively, and has been certified by the developer to meet Apple performance standards. iPhone and iPod are trademarks of Apple, Inc., registered in the U.S. and other countries.

Availability of Android Auto™ may vary depending upon your country and phone model. Please visit android.com/auto for more information. Android, Android Auto, Google and other marks are trademarks of Google Inc.

Other trademarks and trade names are those of their respective owners.

Table of Contents	Page
Warning Statement	3
FCC Compliance	4
Wiring Diagram	5
Preparation Control Locations	6-8
General Operation	9-10
Screen Operation	11-12
Audio Operation	13
AM/FM Tuner Operation	14
USB Operation	15
Media Compatibility	16
Bluetooth Operation	17-18
Driver Orientation Settings	19
Apple CarPlay	20-21
Android Auto	22-23
Auxiliary Inputs/Front & Rear Camera Operation	24
SWC Input Operation	25
Trouble Shooting	26
Specifications	27
Warranty	28

WARNING

Upon installation of this monitor/media player ("unit") into a vehicle, the driver of the vehicle must not operate this unit by watching videos or playing video games while driving. Failure to follow this instruction could lead to driver distraction which could result in serious injury or death to the vehicle's occupants or persons outside the vehicle and/or property damage.

Several states prohibit the installation of monitors/media players if the screen is visible from the driver's seat. If you reside in a jurisdiction which has enacted such a law, this unit must not be installed so that the screen is visible from the driver's seat. When installing this unit in the front console/dashboard, the unit must be positioned so that it is facing the front passenger seat only. Failure to follow this instruction could lead to driver distraction which could result in serious injury or death to the vehicle's occupants or persons outside the vehicle and/or property damage.

This unit is designed so that it may be operated only when the vehicle is in "Park" and the parking brake is fully engaged. To this end, this unit includes a parking brake lock-out feature which prohibits the unit from operating if the vehicle is not in "Park" and/or the parking brake is not fully engaged. When installing this unit, the installer must connect the parking brake detect wire to the parking brake mechanism in order to make the parking brake lock-out feature operable. DO NOT simply ground the parking brake detect wire to a metal portion of the vehicle. Failure to properly install the parking brake lock-out feature could lead to driver distraction which could result in serious injury or death to the driver's occupants or persons outside the vehicle and/or property damage.

Once the parking brake lock-out feature is installed, the owner/user must not attempt to disrupt/neutralize the parking brake lock-out feature by (a) partially engaging the parking brake and/or (b) purchasing/using any device or unit designed to send necessary brake signals to the unit. Failure to follow these instructions could lead to driver distraction which could result in serious injury or death to the driver's occupants or persons outside the vehicle and/or property damage.

When operating this unit, keep the unit's volume level low enough so that the vehicle's occupants can hear traffic-related sounds such as police and emergency vehicles. Failure to follow this instruction could lead to driver distraction which could result in serious injury or death to the vehicle's occupants or persons outside the vehicle and/or property damage.

FCC Compliance

This device complies with Part 15 of the FCC Rules. Operation is subject to the following two conditions:
(1) this device may not cause harmful interference, and
(2) this device must accept any interference received, including interference that may cause undesired operation.

Warning: Changes or modifications to this unit not expressly approved by the party responsible for compliance could void the user's authority to operate the equipment.

This equipment complies with FCC radiation exposure limits set forth for an uncontrolled environment. This equipment should be installed and operated with a minimum distance of 20cm between the radiator & your body.

This transmitter must not be co-located or operating in conjunction with any other antenna or transmitter.

Note: This equipment has been tested and found to comply with the limits for a Class B digital device, pursuant to Part 15 of the FCC Rules. These limits are designed to provide reasonable protection against harmful interference in a residential installation. This equipment generates, uses and can radiate radio frequency energy and, if not installed and used in accordance with the instructions, may cause harmful interference to radio communications. However, there is no guarantee that interference will not occur in a particular installation. If this equipment does cause harmful interference to radio or television reception, which can be determined by turning the equipment off and on, the user is encouraged to try to correct the interference by one or more of the following measures:

- | Reorient or relocate the receiving antenna.
- | Increase the separation between the equipment and receiver.
- | Connect the equipment into an outlet on a circuit different from that to which the receiver is connected.
- | Consult the dealer or an experienced radio/TV technician for help.

Wiring Diagram-Inputs/Outputs

Note: Works for Apple CarPlay and Android Auto only.

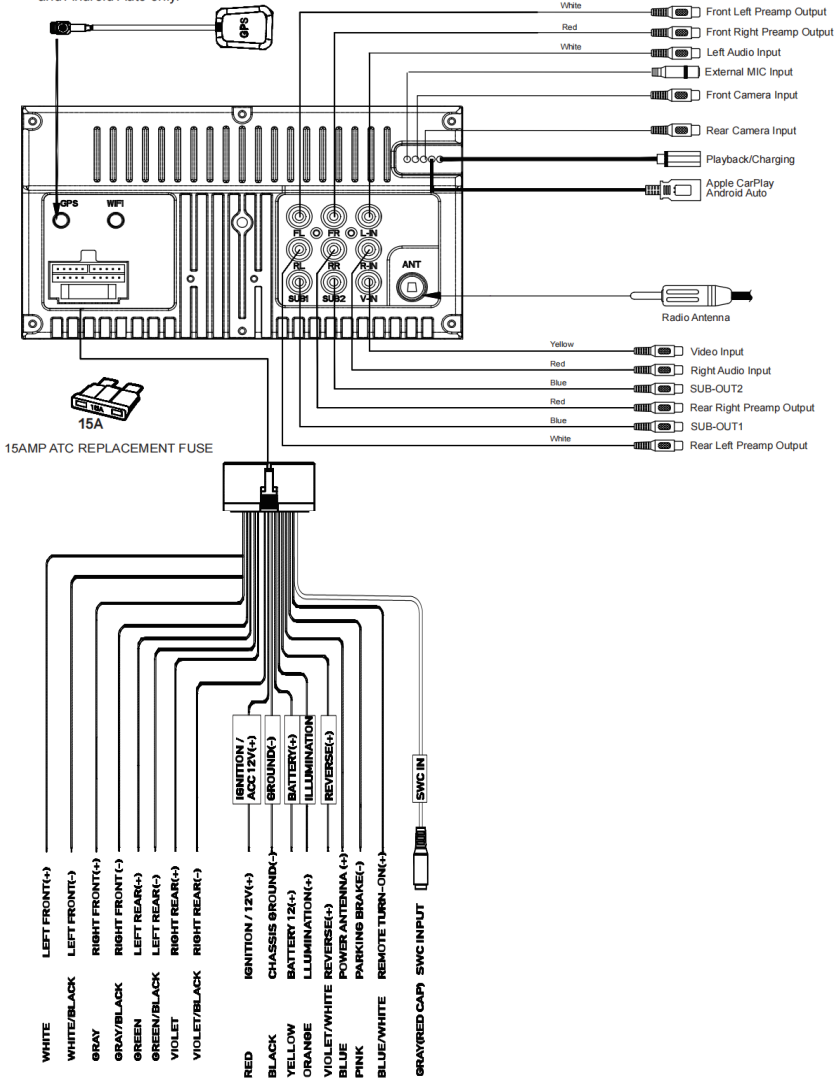

Note:

When replacing a fuse, make sure to use the correct type and amperage. Using an incorrect fuse could cause damage. The unit uses (1) 15 amp ATC mini style fuse located on the power connector.

Rear camera input

A rear view camera (not included) can be used with the Camera input.

Installation

Before You Start

Disconnect negative battery terminal. Consult a qualified technician for instructions.

Avoid installing the unit where it would be subject to high temperatures, such as from direct sunlight, or where it would be subject to dust, dirt or excessive vibration.

INSTALLATION GUIDE

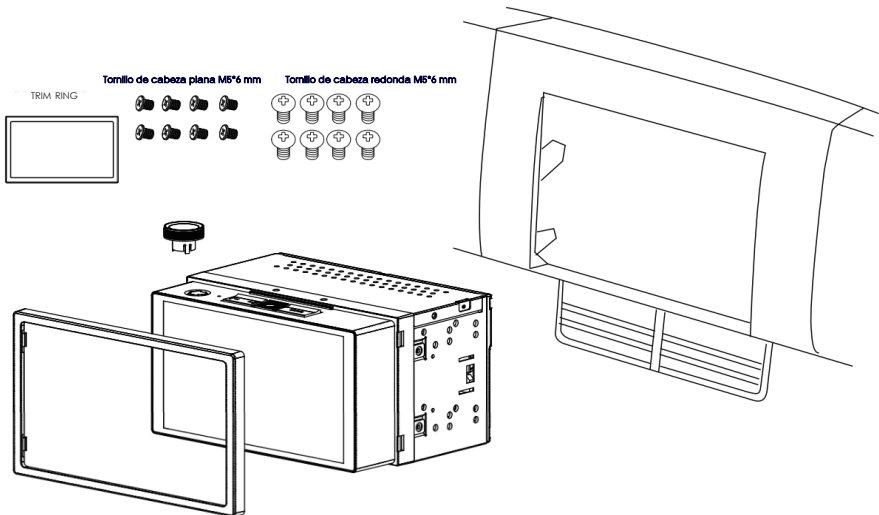

Installation

Before You Start

Disconnect negative battery terminal. Consult a qualified technician for instructions.

Avoid installing the unit where it would be subject to high temperatures, such as from direct sunlight, or where it would be subject to dust, dirt or excessive vibration.

How to attach and remove the Trim ring

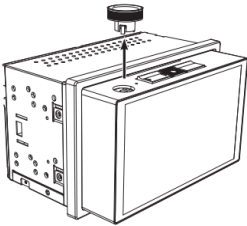
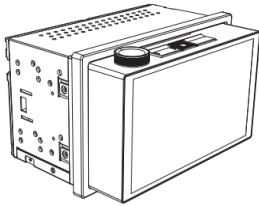

Remove the volume control knob

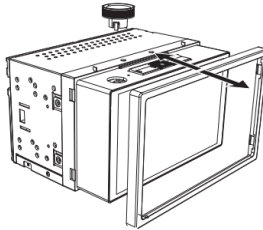

Detach or attach the trim ring

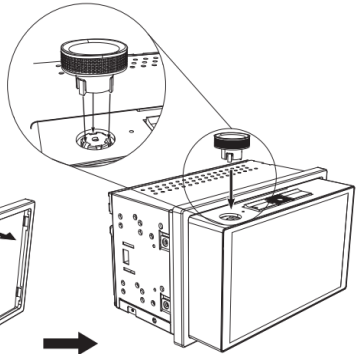

Re-insert the volume control knob

Control Locations

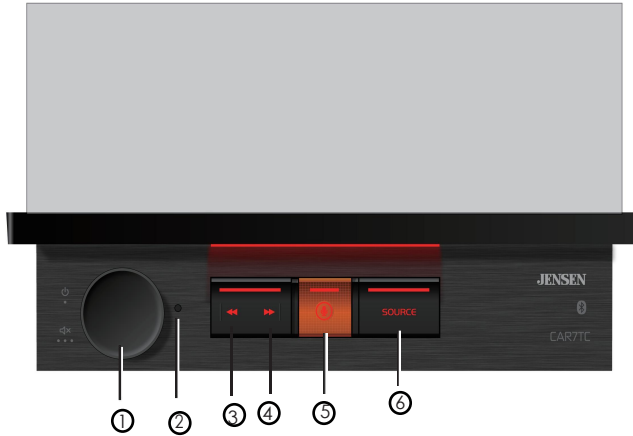

The radio display features the following functions and displays:

- ① Control Knob
 - *Short press to mute/Long press to power off
 - *Rotate to increase or decrease volume
- ② Reset
- ③ Previous/search back
- ④ Next/search forward
- ⑤ CAAA voice button
- ⑥ Source/Home

General Operation

- Power On/Off** Momentarily press  to turn the unit on. Press and hold to turn the unit off.
- Volume** Rotate the **volume knob** to increase or decrease the volume level.
- Mute** Momentarily press **MUTE** to silence the audio. Momentarily press **MUTE** again to return to the previously selected volume. Rotating the **volume knob** while the volume is muted will also cancel the mute function.
- Mode** Press SOURCE to step through the following modes of operation: Radio/BT Phone/BT Audio/Apple CarPlay/Android Auto/USB/Camera/EQ/AV IN/Settings.
- Note: Modes of operation can also be accessed by selecting the corresponding icon from the main menu.

Main Menu Press the  icon in the bottom left corner of the screen to display the OSD main menu. Press the Radio/BT Phone/BT Audio/Apple CarPlay/Android Auto/USB/Camera/AV In/Settings icons to select the desired source.

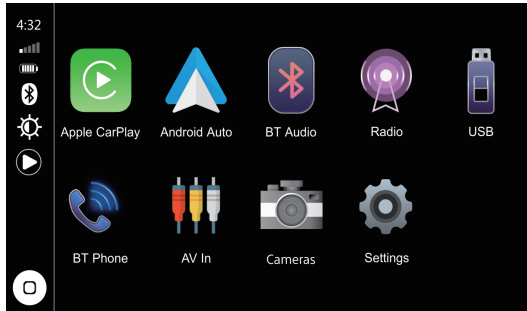

- A/V In** Connect external devices to the rear RCA Type A/V Input.
- USB** Connect a USB flash drive to the rear USB Input.
- Reset** To resolve abnormal operation or if the unit is inoperable, press the RESET button located on the front panel as shown in the Control Locations section. The unit will reset the main processor to the default settings.
- Note:** Use the tip of a pen to access the reset button and restore the factory default software settings.

General Operation

From the Main Menu screen, select Setup to access the Settings menu and select from eight categories represented by the icons on the left of the screen: General, Audio, Display, WiFi, Bluetooth, Camera, Region and Version. Select the category, and adjust any of the available options using the touch screen.

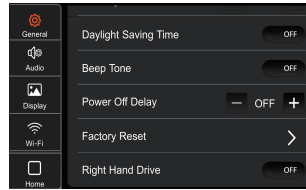
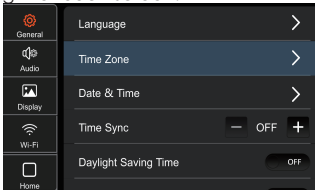

General:

- **Language:** Select between English and Spanish.
- **Time Zone:** Select desired time zone.
- **Date & Time:** Adjust the day, month, year, hour, minute and format.
- **Daylight Saving Time:** Turn On or Off.
- **Beep Tone:** Turn On or Off.
- **Power Off Delay:** Select 1 second, 2 seconds, 3 seconds or Off.
- **Factory Default:** Reset the unit to factory default settings.
- **Right Hand Drive:** Turn On or Off. When the item is off, it is left hand drive mode, and when the item is On, it is right hand drive mode. Default setting is Off (left hand drive mode).

Audio:

- **Balance/Fader-** Select to adjust balance/fader settings.
- **Subwoofer-** Turn the Subwoofer Control On/Off.
- **Subwoofer Frequency-** Select subwoofer frequency.
- **Subwoofer Level -** Select subwoofer 0-14 (7 is default).
- **EQ -** Select to adjust EQ settings.
- **Loudness -** Select to turn Loudness feature On or Off.
- **Default Volume -** Select to adjust default volume settings.
- **Source Level -** Select to adjust source level settings.

Display:

- **Illumination Control -** Select to turn Illumination Control On or Off.
- **Gray Level & Brightness -** Adjust Gray Level & Brightness settings for Day and Night.
- **LED -** Select a color for the LED button lights.
- **LED Animation -** Select to turn LED Animation On or Off.
- **Wallpaper -** Select from six wallpaper options.

WiFi: Turn WiFi On/Off, Reset Password or view Device List.

Bluetooth: Turn Bluetooth, Auto Connect and Auto Answer On/Off, view Device Name and clear Phone Book Names and Numbers.

Camera: Turn Front and Rear Camera On/Off, reverse Camera Views, turn Parking Assistance On/Off, adjust Parking Assistance settings and adjust the Rear View Delay.

Radio: Adjust the Region, and turn TA and AF On/Off.

Version: View version information.

Factory Default-Reset Bluetooth Settings or Reboot System.

Screen Operation

Press the Display icon in the Settings menu to access the Brightness, Contrast, Button Illumination Colors and Wallpaper Settings.

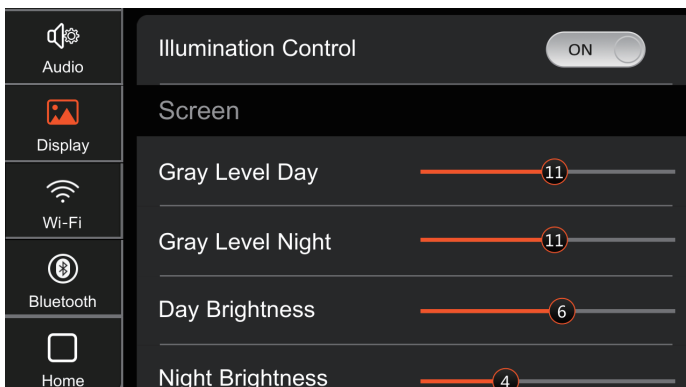

On this interface, you can control the gray level/brightness of screen during the day/night.

- | Gray Level Day: to adjust the gray level of screen during the day. There are a total of 20 levels (from level 1 to level 20, the gray level gradually increases).
- | Gray Level Night: to adjust the gray level of screen at night. There are a total of 20 levels (from level 1 to level 20, the gray level gradually increases).
- | Day Brightness: to adjust the brightness of screen during the day. There are a total of 10 levels (from level 1 to level 10, the brightness gradually increases).
- | Night Brightness: to adjust the brightness of screen at night. There are a total of 10 levels (from level 1 to level 10, the brightness gradually increases).

Screen Operation

Press the Display icon in the Settings menu to access the Brightness, Contrast, Button Illumination Colors and Wallpaper Settings.

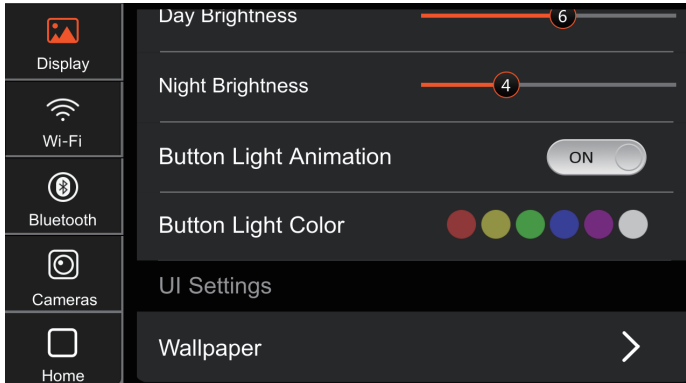

On this interface, you can control color of the button lights.

- 1 Button Light Animation: there are a total of 6 colors for the button lights. Turn on the "Button Light Animation", the color will automatically cycle through these 6 colors.
- 1 Button Light Color: a total of 6 colors (red, yellow, green, blue, purple, white). When you turn off "Button Light Animation", click on the color icon to manually select which color the button light displays.

Audio Operation

Press the AUDIO icon on the main menu screen to enter the audio settings menu.

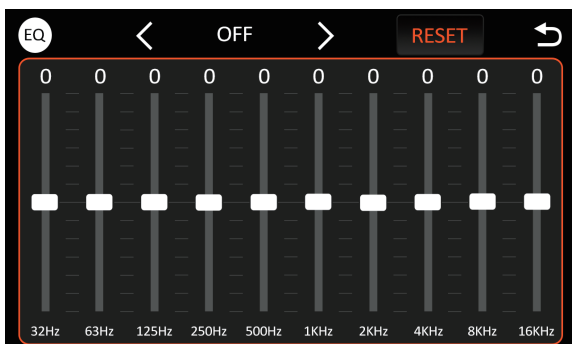
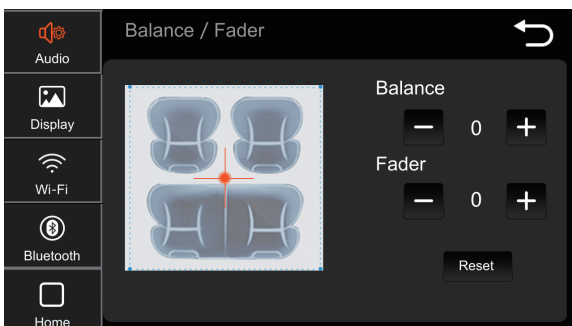
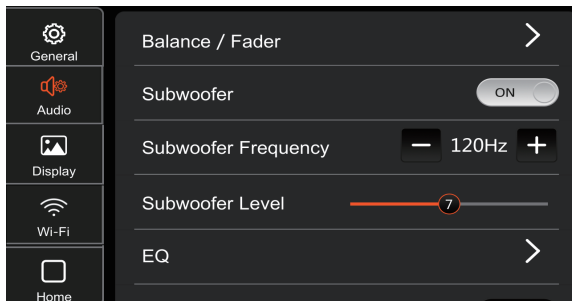

AM/FM Tuner Operation

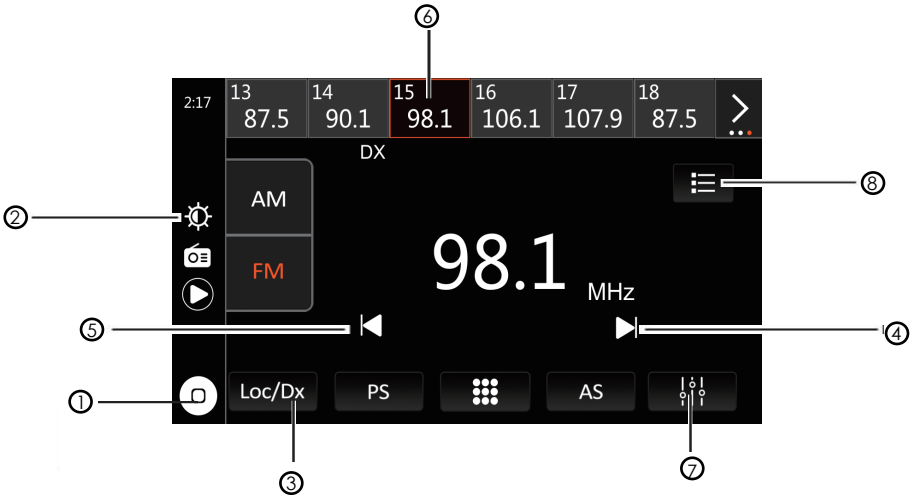

Radio Operation

Main Menu ①

Dimmer ②

Local / Distance ③

Seek Tune Up ④

Seek Tune Down ⑤

Preset Stations ⑥

EQ ⑦

Settings ⑧

From the main menu, touch Radio Icon to select AM/FM tuner mode.

Press to return to Main Menu screen.

Click to control screen brightness.

Press to toggle between local or distance tuning.

Press to automatically tune to a higher frequency.

Press to automatically tune to a lower frequency.

To store a station as a preset in the current band, tune to the desired station, then press and hold the desired preset number to store.

Press any preset button to recall and begin playback of that station.

(Hold this button down for a few seconds and it will switch between AS and PS)

EQ info

Press to access and adjust audio settings.

USB Operation

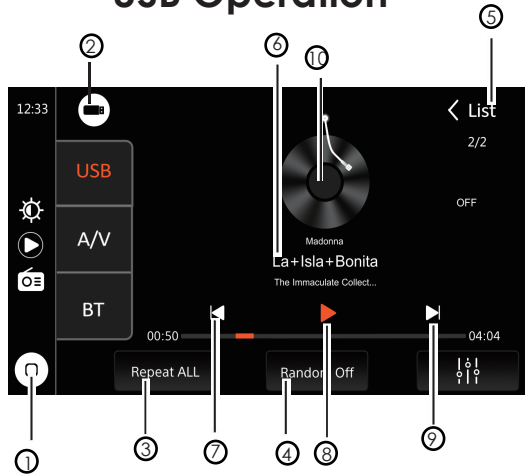

USB

From the main menu, touch the USB icon on the main screen.

- Main Menu ①** Press to return to Main Menu screen.
- Current Mode Indicator ②** Displays source currently playing.
- Repeat ③** Press to repeat current track and adjust to repeat all tracks in the current folder. Press again to exit repeat mode.
- Random ④** Press to shuffle all tracks in the current folder and again to shuffle all tracks. Press again to exit random mode.
- List ⑤** Press to enter the list.
- ID3 Tag Display Area ⑥** Press to see the ID3 information of current song.
- Track Down ⑦** Press to return to the beginning of the current track.
- Play/Pause ⑧** Press to pause or resume playback.
- Track Up ⑨** Press to skip ahead to the next song.
- Album Art ⑩** Press to see the album art information of current song.

Media Compatibility

Media Compatibility

The following types of files are not compatible:

- MP3 PRO format, MP3 playlists
- RMP format
- AAC, protected AAC, M4A format

Playback Order

MP3 playback sequence begins in the root folder of the USB device. Any empty folders or folders that do not include MP3 files are skipped.

Compatible Recording Formats

ISO9660 standards:

- Maximum nested folder depth is 8 (including the root folder).
- Valid characters for folder/file names are letters A-Z (all caps), numbers 0-9, and "_" (underscore). Some characters may not be displayed correctly, depending on the character type.
- This device can play back files in Joliet and other standards that conform to ISO9660. MP3 written in the formats other than the above may not play and/or their file names or folder names may not be displayed properly.

Notes

Some files may not play or be displayed correctly, depending on sampling rates and bit rates.

For best results, use the following settings when ripping MP3 files: 128 kbps or higher constant bit rate 44.1 kHz or higher sampling frequency.

Bluetooth Operation

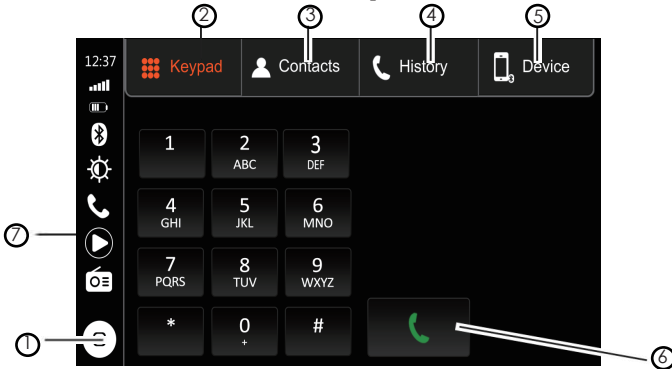

Before using Bluetooth

Before you can use a Bluetooth device to make hands-free calls or stream audio, it must be authenticated. This is also referred to as "pairing" a device.

Pairing a New Device

The unit broadcasts the pairing signal constantly when no devices are currently connected. Complete the pairing sequence from your Bluetooth device. Refer to the owner's manual for your device for more details. **The device name is "CAR7TC"**. The unit can be in any mode of operation when pairing is performed. On certain phones, pairing may need to be done more than once.

Connect

The head unit will automatically connect to the last connected device when the connect feature is set to Auto connect On. If the connect feature is set to Auto Connect Off, the head unit will not automatically connect to any device.

Bluetooth Phone

From the main menu, touch the **Bluetooth** on the screen. Bluetooth icon will appear anytime a Bluetooth device is connected.

Main Menu ①

Press to return to Main Menu screen.

Keypad ②

Press to display the keypad.

Contact ③

Press to display contact list.

History ④

Press to display the recent call list.

Device ⑤

Press to display the device list.

Call ⑥

Press to connect a call.

Phone Keypad ⑦

Use the Phone Keypad to enter a phone number.

Bluetooth Operation

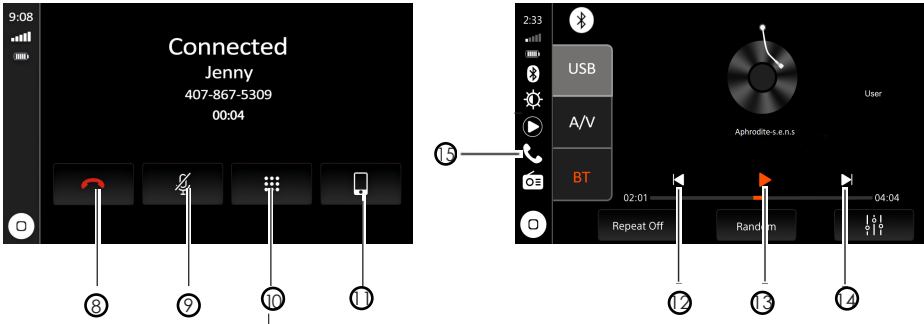

- End Call** ⑧ Press to end a call in progress or reject an incoming call.
- Microphone** ⑨ Press to turn the Microphone voice On or Off.
- Phone Keypad** ⑩ Press to enter a phone number.
- Audio Transfer** ⑪ Press to transfer audio between the unit and mobile phone.
- Track Down** ⑫ Press ◀ icon to return to the beginning of the current track.
- Play / Pause** ⑬ Press ▶/|| icon to pause or resume playback.
- Track Up** ⑭ Touch ▶ icon to skip ahead to the next song.
- Bluetooth Phone** ⑮ Press to switch to Bluetooth phone.

JENSEN

CAR7TC

Driving Orientation Settings

To enhance the driving experience, the CAR7TC allows the user to configure Apple CarPlay and Android Auto for either Left Hand Drive (LHD) or Right Hand Drive (RHD) vehicles.

To select desired configuration, select either LHD or RHD from the Settings menu.

Note: If you change the setting for Right Hand Drive mode or Left Hand Drive mode while the phone is connected to the receiver, disconnect the phone from the receiver and re-connect it again.

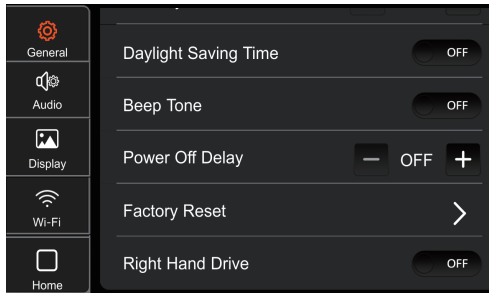

The resulting configuration options are shown below:

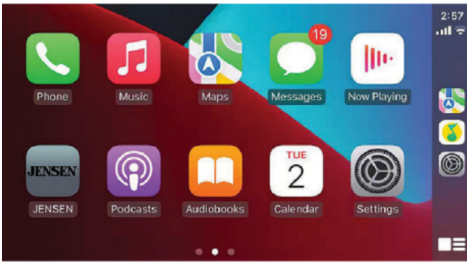

Apple CarPlay - Left Hand Drive



Apple CarPlay - Right Hand Drive

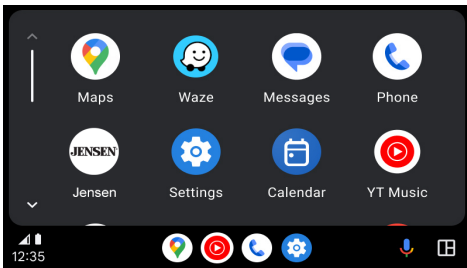

Android Auto - Left Hand Drive

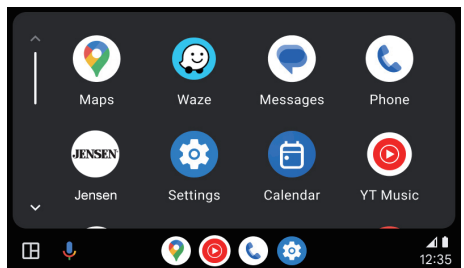

Android Auto - Right Hand Drive

Apple CarPlay® Operation

Apple CarPlay is a smart interface for iPhone, allowing you to voice-control (via Siri) music, navigation, phone and messaging apps—significantly reducing driver distraction.



Phone - Use Siri to make calls, return missed calls, listen to voicemail messages, and view the caller ID on the receiver's screen.



Messages - Ask Siri to send, read, and reply to text messages. This hands free operation minimizes distraction and allows you to keep hands on the wheel and eyes on the road.



Music - Access music by artist, song, playlist, and more through the receiver's touchscreen or via Siri. The receiver will mirror the iPhone screen with artist and track information.



Maps - Use Siri to request turn-by-turn directions — search by address or points of interest. Apple Maps will be mirrored on the screen, including traffic information and estimated time to destination.

Compatible Devices

Made for iPhone models:

iPhone 6S – iPhone 16 Pro Max

Starting Apple CarPlay

Wireless CarPlay Connection Description.

1. Enter the main GUI and click BT Phone to enter the Bluetooth interface;
2. Click Refresh to search nearby Bluetooth, click Pair to match Bluetooth;
3. Open the iPhone WLAN to connect to the car, after the connection is successful, the Apple CarPlay icon in the device list will appear, and the Apple CarPlay connection is successful;
4. Enter the Apple CarPlay interface, click the functions of Phone/ Music/Map/Information/etc.

Note: For safety reasons, Apple CarPlay features are limited while driving and will vary with each Apple CarPlay-enabled app. Available functions are determined by each individual app provider. For more information, visit www.apple.com/ios/carplay.

Note: Certain iPhone functions may be illegal while driving in your location. Be sure to familiarize yourself with local and state laws regarding mobile devices. When in doubt, stop and park your vehicle before using any devices.

Apple CarPlay® Operation

When the Apple CarPlay menu is displayed, the home button in the lower left corner work just like the home button on your iPhone.

- Ⓞ Press and hold it to summon Siri and begin your voice commands.
- Ⓞ At any time during Apple CarPlay operation, you can press this button momentarily to return to the main Apple CarPlay menu screen.



Press any Application button on the main Apple CarPlay menu to access that operation directly. The toolbar on the left side of the screen displays the time, signal strength and shortcuts to the most popular applications - Phone, Music and Navigation - so they can be accessed quickly and easily without returning to the main menu.

Controlling Apple CarPlay

The following basic controls will operate many standard Apple CarPlay features.



Touch - Briefly press the desired option.



Swipe - Briefly swipe in the desired direction.



Drag - Press, hold and drag to the desired location.

Exiting Apple CarPlay

Disconnecting your iPhone will automatically exit Apple CarPlay mode. To exit Apple CarPlay mode while your phone is still connected, press the Power/Volume knob momentarily, and the unit's main menu will be displayed.

Android Auto™ Operation

Android Auto brings the most useful apps to your phone screen or your compatible car display, in a format that makes it easy for you to keep your main focus on driving. You can control things like navigation and maps, calls and text messages, and music.

Google Assistant

With your Google Assistant on Android Auto, you can keep your eyes on the road and your hands on the wheel while using your voice to help you with your day. Simply say, "Ok Google," or in compatible cars, long press the voice control button on your steering wheel.

Navigation

Get real-time traffic alerts to avoid hazards, speed traps, and find the fastest route. Or take a break and find a bite along the way.

Calls & Messages

Your Google Assistant lets you stay connected while you're driving. Your Assistant can help you call phone numbers from your contacts, chat with your favorite apps, read your messages aloud and text back, keeping your hands on the wheel.

Compatible Devices

Android Auto requires the Android Auto app from Google Play installed on an Android smartphone running Android Lollipop 5.0 or higher.

Warning:

Certain uses of the smartphone may not be legal while driving in your jurisdiction, so you must be aware of and obey any such restrictions. If in doubt as to a particular function, only perform it while the car is parked. No feature should be used unless it is safe to do so under the driving conditions you are experiencing.

Starting Android Auto

Wireless Android Auto Connection Description.

1. Enter the main GUI and click BT Phone to enter the Bluetooth interface;
2. Click Refresh to search nearby Bluetooth, you'd better turn on your Phone's WLAN before you connect to Bluetooth, otherwise the connection will fail;
3. Click Pair to match Bluetooth, then there will be a notification to select settings and select your mobile Phone, and the Android Auto connection is successful;
4. Enter the Android Auto interface, click the functions of Phone/ Music/Map/Information/etc.

Note: When the device for Android Auto is connected to this unit, the device is also connected via Bluetooth at the same time. If five devices are already paired, the message confirming whether to delete the registered device is displayed. If you want to delete the device, touch [Agree]. If you want to delete other device, touch [BT Settings] and delete the devices manually.

Note: If Android Auto is turned on during a call on a cellular phone other than the Android Auto compatible device, the Bluetooth connection will switch to the Android Auto compatible device after the call.

Android Auto™ Operation

Using Android Auto

The Android Auto home screen displays personalized information, like time to your destination, reminders, recent calls incoming messages, the song you're listening to, and Google Now cards.

When the Android Auto menu is displayed, you can say "OK Google" or select the microphone in the lower left corner to talk to Google.

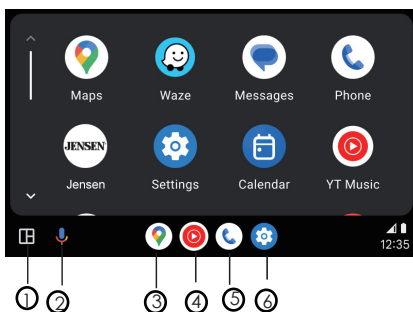

- ① Recent Apps
- ② Google Assistant
- ③ Google Maps
- ④ YouTube
- ⑤ Phone
- ⑥ Settings

Exiting Android Auto

To exit Android Auto, press the Exit button. Disconnecting your Android phone will automatically exit Android Auto mode.

Rear RCA Input

A/V IN | Connect an optional audio/video source into the RCA (rear) input.

Adjust volume on the external audio source as needed (if connected to the headphone output of the device)

Front and Rear Camera Operation - (Optional)

Using the Cameras

Connect an optional camera to the front or rear Camera Input. Refer to the wiring diagram for details.

Auto Selection

The unit will automatically select camera mode when connected to the reverse lamp circuitry.

Touch the CAMERA icon on the Main Menu (when enabled) to select camera mode. Touch the bottom left area of the screen to return to the Main Menu to turn this feature off.

Note: The manual mode is for dedicated cameras that are connected to the 12VDC+ ignition wire and are always on while driving, it is not meant for cameras that are connected to the vehicle's reverse light.

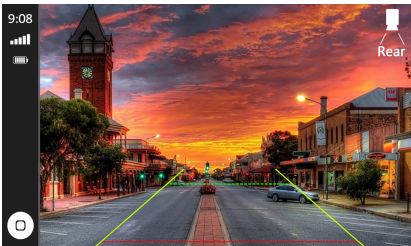

Adjusting Front and Rear Camera Screen Image

If your front or rear cameras appear to have a reversed image on the radio's display, go into the Camera section in the Settings menu to reverse the image of the camera. To do this, toggle the "Rear Camera View Reverse" or "Front Camera View Reverse" function to correct the viewing angle of the camera(s).

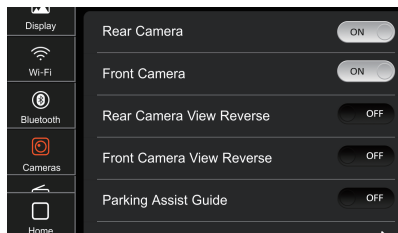

JENSEN

CAR7TC

SWC Input Operation

The built-in SWC Interface is compatible with PAC steering wheel control modules.

The PAC SWI-RC is recommended. A third-party adapter must be used in order for the CAR7TC to be compatible with any steering wheel controls. The following controls are available for most vehicles.

1. Preset Up/Down	4. Seek/Track Down (-)	7. Volume Down (-)	10. BT End
2. Mode	5. Mute	8. Band	
3. Seek/Track Up (+)	6. Volume Up (+)	9. BT Talk	

Note: Not all OE steering wheel functions may be supported by the CAR7TC.

PAC SWI-RC Installation Hints

1. Set "Radio Select Switch". Set the SWI-RC to position 7 - "Pioneer/Other/Sony".
2. To program, use the Pioneer/Sony/Other radio function mapping order for Jensen units.
3. When programming the SWI-RC, if a function is not supported (or not desired), then the function MUST be skipped as per the PAC SWI-RC instructions.
4. The SWC function MUST be programmed in the correct order per the PAC SWI-RC radio function mapping order instructions.

Function Order	Function Mapping	SWI-RC (3.3VDC Reference)	
		Center Pin (Ring) Voltage (Function Select)	Tip Pin Voltage
1	Preset Up/Down	L 0.0V	1.54/1.81
2	Mode	H 3.3V	0.6
3	Seek + / Track +	H 3.3v	1.54
4	Seek - / Track -	H 3.3v	1.81
5	Mute	H 3.3v	1.01
6	Volume +	H 3.3v	2.07
7	Volume -	H 3.3v	2.32
8	Band	H 3.3v	2.73
9	BT Talk	L 0.0V	0.60
10	BT End	L 0.0V	1.01

Troubleshooting

General		
Problem	Cause	Action
Unit will not turn on (no power)	Yellow wire not connected or incorrect voltage. Red wire not connected or incorrect voltage	Check connections for proper voltage (11~16VDC)
	Black wire not connected	Check connection to ground
	Fuse blown	Replace fuse(s)
Unit has power (but no sound)	Speaker wires not connected	Check connections at speakers
	One or more speaker wires touching each other or touching chassis ground	Insulate all bare speaker wires from each other and chassis ground
Unit blows fuse(s)	Yellow or red wire touching chassis ground	Check for pinched wire
	Speaker wires touching chassis ground	Check for pinched wire
	Incorrect fuse rating	Use fuses with correct rating
Unit has audio (but no video)	Parking brake safety circuit not connected Parking brake not applied	Check connections at parking brake Apply parking brake as described in manual
IR remote does not work	Dead battery	Replace battery

Firmware Upgrades

If a product or software update becomes available, you may find these updates on our website under your product model number.

Please go to www.jensenmobile.com to check for new updates.

Updates can be completed with a user supplied USB drive, typically 8GB or 16GB in size from one of the below recommended manufacturers:

SanDisk, Kingston, PNY, Samsung, Corsair or Verbatim.

These are readily available online or at most retail locations that sell electronics.

The drive needs to support USB 2.0 or faster transfer speeds. Older version USB 1.0 is not compatible. Format the drive using the FAT32 file system.

For Your Records

Please keep your original sales receipt and be prepared to provide this receipt in the event you require service, as your original receipt is considered the best proof of purchase and indicates the date you purchased your Jensen product.

Dealer Name _____
 Dealer Phone _____
 Purchase Date _____

Register Your Product

Register your product online at www.jensenmobile.com.

Specifications

FM Tuner	Tuning range: 87.5MHz-107.9MHz Usable sensitivity: 10dBf 50dB quieting sensitivity: 20dBf Stereo separation @ 1kHz: 38dB Frequency response: 30Hz-13kHz
AM Tuner	Tuning range: 530kHz-1710kHz Usable sensitivity: 24uV Frequency response: 30Hz-2.3kHz
Rear USB	Compatibility: High Speed USB 2.0 USB Class: Mass storage class (There are two USB ports: 1. USB-C: for Charging and Playback; 2. USB-A: only for AA/CP with charging but no playback)
Monitor	Panel size: 7" diagonal measurement View angle (up/down/left/right): 50/70/70/70 Resolution: 1280(H) x 720(V) Brightness (cd/m2): 500 Contrast ratio: 500:1 Pixels: 2,764,800
General	Speaker output impedance: 4 ohms Line output voltage: 4 volt RMS Line output impedance: 200 ohms Chassis dimensions: 8" X 4.1" X 2" (W x D x H)

Design and specifications subject to change without notice.



CEA-2006 Power Standard Specifications

(reference: 14.4VDC +/- 0.2V, 20Hz~20kHz)

Power Output: 16 Watts RMS x 4 channels at 4 ohms
and $\leq 1\%$ THD+N Signal to Noise Ratio: 80 dBA
(reference: 1 watt into 4 ohms)

Limited Two Year* Warranty

This warranty gives you specific legal rights. You may also have other rights which vary from state to state.

Jensen warrants this product to the original purchaser to be free from defects in material and workmanship for a period of two years from the date of the original purchase.

Jensen agrees, at our option, during the warranty period, to repair any defect in material or workmanship or to furnish an equal new, renewed, or comparable product (whichever is deemed necessary) in exchange without charges, subject to verification of the defect or malfunction and proof of the date of purchase. Subsequent replacement products are warranted for the balance of the original warranty period.

What is covered? This warranty covers all defects in the material and workmanship in this product. The following are not covered: software, installation/removal costs, damage resulting from accident, misuse, abuse, neglect, product modification, improper installation, incorrect line voltage, unauthorized repair, or failure to follow instructions supplied with the product, or damage occurring during return shipment of the product. Specific license conditions and copyright notices for the software can be found via www.jensenmobile.com.

Warranty Coverage

* Limited 2-year warranty. (Proof of purchase required)

- Extended Coverage: Extend your warranty from 2 years to 4 years when you register online at www.jensenmobile.com. Registration must be completed within 60 days of the original purchase date to qualify for this extension.

What to do?

1. Before you call for service, check the troubleshooting guide in your owner's manual. A slight adjustment of any custom controls may save you a service call.
2. If you require service during the warranty period, you must carefully pack the product (preferably in the original package) and ship it by prepaid transportation with a copy of the original receipt from the retailer to an authorized service center.
3. Please describe your problem in writing and include your name, a return UPS shipping address (P.O. Box not acceptable), and a daytime phone number with your shipment.
4. For more information and for the location of the nearest authorized service center please contact us by one of the following methods:
 - a. Call us toll-free at (888) 921-4088 (Monday-Friday, 9:00 am, to 5:00 pm, EST)
 - b. E-mail us at cs@jensenmobile.com

Exclusion of Certain Damages: This warranty is exclusive and in lieu of any and all other warranties, expressed or implied, including without limitation the implied warranties of merchantability and fitness for a particular purpose and any obligation, liability, right, claim or remedy in contract or tort, whether or not arising from the company's negligence, actual or imputed. No person or representative is authorized to assume for the company any other liability in connection with the sale of this product. In no event shall the company be liable for indirect, incidental, or consequential damages.



Customer Support

1-888-921-4088

(Monday-Friday, 9AM-5PM EST)

Visit <https://www.jensenmobile.com>

Designed and Engineered in USA

JENSEN[®]

All rights reserved. No part of this publication may be reproduced, distributed, or transmitted in any form or by any means, including photocopying, recording, or other electronic or mechanical methods, without the prior written permission of NAMSUNG AMERICA INC.